



North Atlanta Home Show

Infinite Energy Arena (Gwinnett Center) - Duluth, Georgia
February 7 - 9, 2020

Event Code: G175700220
email atlanta@shepardes.com
phone (404) 720-8600
fax (404) 720-8755
mail 1531 Carroll Drive, NW Atlanta, GA 30318

BOOTH PACKAGE

Items provided in your booth, per exhibitor:

8' High backwall drape, 3' High sidewall drape
7" x 44" Cardstock Identification Sign

Show drape color(s): Black
Aisle carpet color: Eclipse

Exhibit Show Schedule

General Exhibitor Move-in:

Tuesday, February 4, 2020 8:00 AM to 8:00 PM
Wednesday, February 5, 2020 8:00 AM to 8:00 PM
Thursday, February 6, 2020 8:00 AM to 8:00 PM

Exhibit Hours:

Friday, February 7, 2020 10:00 AM to 6:00 PM
Saturday, February 8, 2020 10:00 AM to 7:00 PM
Sunday, February 9, 2020 11:00 AM to 5:00 PM

Exhibitor Move-out:

Sunday, February 9, 2020 5:00 PM to 11:45 PM
Monday, February 10, 2020 8:00 AM to 12:00 PM

Freight Reroute Begins*

Monday, February 10, 2020 12:00 PM *All outbound carriers must be checked in by this time

Shipping Addresses

See Material Handling Rate Form for all related fees.

Advance Shipments Address

[Exhibiting Co. Name & Booth Number]
North Atlanta Home Show
c/o Shepard Exposition Services
1790 Marietta Blvd
Atlanta, GA 30318

Direct Shipments Address

c/o Shepard Exposition Services
[Exhibiting Co. Name & Booth Number]
North Atlanta Home Show
Infinite Energy Arena (Gwinnett Center)
6400 Sugarloaf Pkwy, Ste 100
Duluth, GA 30097

Important Deadlines

Discount price deadline for custom Shepard rentals: Wednesday, January 8, 2020
Exhibitor appointed contractor notification deadline: Wednesday, January 8, 2020
First day for warehouse deliveries without a surcharge: Wednesday, January 8, 2020
Discount price deadline for standard Shepard orders: Friday, January 17, 2020
Last day for warehouse deliveries without a surcharge: Tuesday, January 28, 2020
Last day for warehouse deliveries*: Friday, January 31, 2020

Date indicated is last day freight can arrive to advanced warehouse with guarantee of delivery to booth for exhibitor move-in.

First day freight can arrive at show facility: Tuesday, February 4, 2020 at 8:00 AM

North Atlanta Home Show

Infinite Energy Arena (Gwinnett Center) - Duluth, Georgia

February 7 - 9, 2020

Discount Deadline Friday, January 17, 2020

Event Code:

G175700220

email

atlanta@shepardes.com

phone

(404) 720-8600

fax

(404) 720-8755

Shepard Mailing Address 1531 Carroll Drive, NW Atlanta, GA 30318**Due to liability concerns and/or labor jurisdictions, exhibitors or their EACs may not operate any type of mechanical or powered equipment including forklifts, electric pallet jacks, overhead lifts, etc.****Service Desk Hours** (subject to change)

Tuesday, February 4, 2020	8:00 AM	to	8:00 PM
Wednesday, February 5, 2020	8:00 AM	to	8:00 PM
Thursday, February 6, 2020	8:00 AM	to	8:00 PM
Friday, February 7, 2020	10:00 AM	to	6:00 PM
Saturday, February 8, 2020	10:00 AM	to	7:00 PM
Sunday, February 9, 2020	11:00 AM	to	5:00 PM
Sunday, February 9, 2020	5:00 PM	to	11:45 PM
Monday, February 10, 2020	8:00 AM	to	12:00 PM

Exhibitor Move Out

Sunday, February 9, 2020	5:00 PM	to	11:45 PM
Monday, February 10, 2020	8:00 AM	to	12:00 PM

Dismantle & Move out Information

Shepard will begin returning empty containers and skids as soon as the aisle carpet is removed from the floor.

All exhibitor materials must be removed from the facility by Monday, February 10, 2020 12:00 PM

Any materials remaining in the hall will be rerouted or returned to Shepard's warehouse to await disposition at the exhibitor's expense.

To ensure all exhibitor materials are removed from the facility during the exhibitor move out, please have all carriers checked in with Shepard no later than Monday, February 10, 2020 12:00 PM

Post Show Paperwork & Labels

Our Customer Service Representatives will gladly assist you in preparing your outbound shipping labels, outbound Material Handling Authorization paperwork, and outbound shipping in advance. You may find these forms included in this exhibitor services catalog. An email with links to an online portal will also be sent to the exhibitor contact on record for the booth.

Labels and paperwork will also be available onsite. Make sure your carrier knows your company name, booth number, and the carrier check in deadline.

Outbound Shipping

It is the responsibility of each exhibitor to arrange for transportation of booth materials after the event. Our Customer Service Representatives are available pre show, during the show, and during move out to assist you in arranging shipping through our official carrier Shepard Logistics. For peace of mind and easy set up, contact Shepard Logistics before the event for transportation services to and from the event.

Shepard does not provide UPS, FED-EX, or other carrier specific labels. Exhibitors must schedule pick ups directly with all carriers as well as provide carrier specific shipping labels.

Pick Up Address

Infinite Energy Arena (Gwinnett Center)
6400 Sugarloaf Pkwy, Ste 100
Duluth, GA 30097

North Atlanta Home Show

Infinite Energy Arena (Gwinnett Center) - Duluth, Georgia

February 7 - 9, 2020

Discount Deadline Friday, January 17, 2020

Order with complete Payment Authorization must be received before Discount Deadline date to receive discounted pricing.

Event Code: G175700220
 email: atlanta@shepardes.com
 phone: (404) 720-8600
 fax: (404) 720-8755

A Budget and Time Friendly Solution!

Step 1: Select your package:

Booth Package 10' X 10' (50260A)

Each Economy 10x10 booth package includes:

- 1 - 6'L x 24"W x 30"H Skirted Table - Black 5004606
- 2 - Upholstered Side Chairs 50020
- 1 - Wastebasket 50091
- 1- 10 X 10 Carpet 50255

No substitutions will be accepted.

Code	Qty	Discount	Regular	Amount
50260		\$527.95	\$686.35	

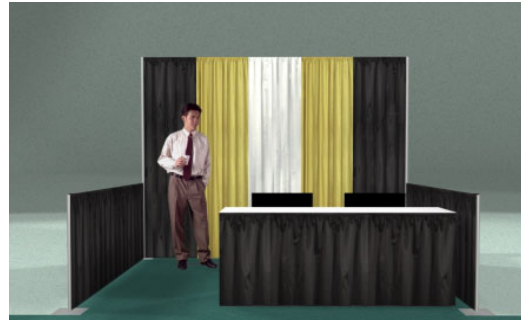

Drawing shown is not indicative of the show colors, please see Show Info for your specific drape colors.

Booth Package 10' X 20' (50260B)

Each Economy 10x10 booth package includes:

- 1 - 6'L x 24"W x 30"H Skirted Table - Black 5004606
- 2 - Upholstered Side Chairs 50020
- 1 - Wastebasket 50091
- 1- 10 X 20 Carpet 50256

No substitutions will be accepted.

Code	Qty	Discount	Regular	Amount
50260		\$711.25	\$924.65	

Step 2: Choose your carpet color:



To qualify for the discounted rate listed above, order must be received with payment by **Friday, January 17, 2020**

Orders received after the discount deadline will no longer be package orders and will be placed for each individual item at the Regular catalog rates.

Submission of this form indicates you read and accept the Payment Policy and Terms & Conditions.

All orders cancelled by the exhibitor within 30 days of first day of exhibitor move in day may be subject to cancellation fees up to 100% of the total order, based upon the status of move-in, work performed and/or Shepard set-up costs or expenses. * All tax rates are subject to change.

Total Econo Booth Pac: \$ _____
 6.000% Tax*: \$ _____
 Amount Due: \$ _____

Company Name: _____ Booth # _____

Contact Name _____

Email: _____

Signature: _____

North Atlanta Home Show

Infinite Energy Arena (Gwinnett Center) - Duluth, Georgia

February 7 - 9, 2020

Event Code:

G175700220

email

atlanta@shepardes.com

phone

(404) 720-8600

fax

(404) 720-8755

Online Ordering is Easy!

Go to: www.shepardes.com/intro.asp**CLICK ON** North Atlanta Home Show**Login** from the Show Information page by clicking  at the top right corner of the page.**Enter** your email address and password then click **NEW users :** User name = Your Email Address (provided by Event Management)

Password = NAHS20

Prior users : User name = Your Email Address

Password = Your pre-existing password

Don't remember your password? Click the link [Forgot your password?](#) and follow the prompts to have your password sent to the registered email address.Once logged in, please confirm your profile information. If you need to update your information, please contact us at customerservice@shepardes.com

To order, utilize the grey category dropdown menus above the Welcome message.

After making your selections, click the  button on the bottom right of the page.To view your order click the  Shopping Cart Icon at the top right of the page.Confirm your order, click  and complete the payment process.

* Material Handling estimates will not be charged until freight is received at the warehouse or at show site.

* Labor and Hanging Sign estimates will not be charged until services are rendered at show site.

If you need assistance during your shopping experience, contact us using our  feature on the right side of the screen. Representatives are available Monday through Friday 8am - 5pm est.

QUESTIONS?

We love to help! Contact us!

Shepard Customer Service**(404) 720-8600**atlanta@shepardes.com



North Atlanta Home Show

Infinite Energy Arena (Gwinnett Center) - Duluth, Georgia

February 7 - 9, 2020

Event Code: G175700220
email atlanta@shepardes.com
phone (404) 720-8600
fax (404) 720-8755
mail 1531 Carroll Drive, NW Atlanta, GA 30318

Please complete the information and return this form with your orders. You may choose to pay by credit card, check payable to Shepard Exposition Services, or bank wire transfer, however, we require your credit card authorization to be on file before we process your order(s) for service. For your convenience, we will use this authorization to charge your credit card account for any additional amounts incurred as a result of show site orders placed by your representative including material handling and logistics charges for shipments received on your company's behalf and any unpaid balance due for Shepard services. Credits for services will be issued at show site only.

Once a payment is processed by credit card, any changes to the payment method will be charged a fee of 5% of the total invoice, 10010-Change Of Payment Method Transaction Fee

Please complete the following information:

Exhibiting Company Information

Company Name: Booth #
Street Address: Phone:
City, St, Zip: Fax:
Contact Name:
Email:

Credit Card Information

(Required for all forms of payment)

Check Wire Transfer



You may choose to pay by Check or Wire Transfer, however a credit card is required on file to process all orders.

Credit Card #:
Expiration Date: Month Year Security Code
Billing Address:
City, ST, Zip:
Name on Card: (Please Print)
Signature:

By signing the above I acknowledge and understand that ALL services rendered, including Material Handling and Logistics, will be billed to this credit card.

Wire Transfers

In order to accurately process the transfer of funds from your account, please complete the following information and fax it along with a copy of the wire receipt to the fax number printed on the header of this page. A \$50 service charge will be added for processing checks drawn on foreign banks. A \$25 service charge will be added for processing U.S. wire transfers. \$50 service charge for international wire transfers.

The following information must be included on the bank copy of the wire transfer confirmation:

Name of show that you are attending: North Atlanta Home Show
Exhibiting Company Name:
Booth Number:
Account Name: Shepard Exposition Services, Inc. Bank Name: PNC Bank N.A., Pittsburgh, PA 15219 USA
Routing Number: 041000124 Account Number: 42-6061-9772
SWIFT CODE (US): PNCCUS33 SWIFT CODE (INTL PNCCUS33)

Please include the show name, event code and your booth # as well as the wire fee if you are sending a wire transfer, ACH payment, or check.

TAX EXEMPT? Please submit tax exemption certificate to: atlanta@shepardes.com

If you are tax exempt, you must provide a tax exemption certificate for the state in which the event is being held.

You are entering a contract which limits your possible recovery in case of loss or damage.

The terms and conditions set forth below become a part of the contract between Shepard Exposition Services, and you, the Exhibitor. Exhibitor is deemed to accept these terms and conditions when any of the following conditions are met:

Exhibitor materials are delivered to the Shepard warehouse or to a show or exposition site for which Shepard is the Official Show Contractor, or an order for labor and/or rental equipment is placed by the exhibitor with Shepard.

Definitions and Shepard Responsibilities: The name "Shepard" shall be construed within the meaning of this contract as Shepard Exposition Services, Inc. and its employees, officers, agents, and assigns including any subcontractors Shepard may appoint. The term "EXHIBITOR" refers to any party who contracts for services with Shepard. Shepard shall be responsible only for those services which it directly provides, and hereby agrees to execute its contracted duties in good faith. Shepard assumes no responsibility for any person, parties, or other contracting firms not under Shepard's direct supervision and control. Shepard shall not be responsible for loss, delay, or damage due to strikes, lockouts, work stoppages, natural elements, vandalism, acts of God, civil disturbances, power failures, acts of terrorism or war, or any other causes beyond Shepard's reasonable control; or for ordinary wear and tear in the handling of materials. Due to the security and liability requirements, Shepard personnel will unload all vendor materials from the loading docks to the booths. Exhibitors may not utilize powered mechanical equipment.

Indemnification: The exhibitor agrees to indemnify, forever hold harmless, and defend Shepard and its employees, officers and agents from and against any and all claims, causes of action, fines, penalties, damages, liabilities, judgments, and expenses on account of personal injury or death, damage to or loss of property or profits arising out of, or contributed to by any of the following: (1) exhibitor's negligent supervision of any labor secured through Shepard or the negligent supervision of such labor by any of the exhibitor's employees, agents, representative, invitees, and/or exhibitor appointed contractor (EAC); (2) exhibitor's negligence, willful misconduct, or deliberate act, or such actions of exhibitor's employees, agents, invitees, representatives, or EACs at the show to which this contract relates, including but not limited to the misuse, improper use, unauthorized alteration, or negligent handling of Shepard equipment; or (3) exhibitor's violation of Federal, State, or Local ordinance; or violation of show regulations and/or rules as published by the Facility and/or Show Management.

Payments are due prior to delivery of services or equipment to EXHIBITOR unless other credit arrangements have been made. All payments shall be in U.S. currency, MasterCard, VISA, or American Express, debit cards, or check, provided there is sufficient customer credit in Exhibitor's form of payment to completely satisfy the amount owed by EXHIBITOR to Shepard. Undersigned authorizer acknowledges and agrees that all applicable charges for services rendered to the EXHIBITOR will be applied to the credit card on file in the event other form of payment is not tendered prior to the close of the trade show. In no instance shall any Exhibitor be extended credit beyond 30 days after the close of the Show. If there are any outstanding balances owed by EXHIBITOR to Shepard which have not been paid after 30 days following the close of the Show, then these unpaid balances shall bear interest at the rate of 1-1/2% per month (18% per annum). Exhibitor will be responsible for all charges incurred by Shepard while endeavoring to collect this account. If EXHIBITOR provides a credit card for payment and the credit card transaction is declined, EXHIBITOR hereby authorizes Shepard to process the outstanding balance in multiple smaller increments that total the amount of the outstanding payment obligation. In the event that a THIRD PARTY (AGENT) orders on behalf of the EXHIBITOR and the named THIRD PARTY does not discharge payment of the invoice prior to the last day of the show, charges will revert back to the EXHIBITOR. All invoices are due and payable upon receipt, by either party.

Show Site Orders: Services ordered at show site will require full payment at the time the order is placed. Purchase orders may not be used in lieu of payment. Regular prices will apply to all show site orders. Floor orders are limited to availability.

Third Party Orders: If you contract your work to a display or exhibit house and require services from Shepard, the payment policy stated above applies. Please pass this information on to them. A Third Party Payment form must be completed and submitted three weeks prior to show opening.

Equipment Audits: EXHIBITOR should be advised that routine audits of Exhibitor booths for service usage are conducted during the Convention. Should the result of such an audit indicate that equipment or services is in fact being used that has not been paid for, the Exhibitor will be charged for the equipment or service at the applicable rate.

Exchanges and Cancellations: Onsite exchanges and cancellations in orders will be assessed a 100% pick-up fee. Custom products: All orders cancelled by the exhibitor within 30 days of first day of exhibitor move in day may be subject to cancellation fees up to 100% of the total order, based upon the status of move-in, work performed and/or Shepard set-up costs or expenses. Equipment and Furnishings: There are no exchanges or refunds once item has been delivered to your booth. Cancellations must be received in writing within 14 days prior to first exhibitor move in day. Labor: Cancellations must be received in writing before 48 hours of 1st day of exhibitor move in, otherwise a 1 hour per man ordered will apply.

Invoices: Prior to close of show, an invoice will be prepared and emailed to the booth contact on file for your review. Credits will be issued at show site only. If you have any questions or want to pay your invoice by check or cash, please see our customer service representatives at the service desk on site.

Outbound Services: All outbound services will be processed on your credit card. A copy of the receipt and invoice will be mailed within 10 days of the close of the show.

Rental Responsibility: All materials are on a rental basis and shall remain the property of Shepard. The customer shall be held financially responsible for any damage to Shepard equipment used by the customer. Prices quoted are for the duration of the show and include installation, rental, and removal except where indicated. If skirting and carpet colors are not selected, show colors will prevail.

International Customers: International customers must pay for all services in U.S. funds. A \$50 service charge will be added for processing checks or wire transfers drawn on foreign banks.

U.S. Wire Transfers: A \$25 service charge will be added for processing U.S. wire transfers. Please complete the wire transfer portion of the Payment Authorization form. The credit card portion of the form must still be completed before your order will be processed.

Tax Exempt Status: If you are tax exempt in the state where the show is held, a copy of the certificate must accompany your order.

Tax Rates: State tax regulations and tax rates can change after the date of publication. Prevailing state tax rates will supersede any published rate.

Exhibitor Information: Exhibitor permits all contact information provided to Shepard to be used by Shepard and shared with other entities assisting in the production of the event in question. Facsimiles and email communications may include show information, promotional materials, advertising statements and other commercial notices. Permission may be revoked by the EXHIBITOR in writing.

Cancellation or Event Postponement: In the event the exposition or event is cancelled or postponed, Shepard reserves the right to charge for services rendered in preparation of the event or exposition as well as non-refundable costs incurred by Shepard.

Insurance: It is understood that Shepard is not an insurer. Insurance should be obtained by the EXHIBITOR. It is highly recommended that exhibitors arrange All Risk coverage which usually can be done by endorsements to existing policies. Exhibitor's materials should be insured from the time they leave their firm until they are returned after the close of the show. Insurance and liability against theft or property damage to equipment or exhibit material owned or rented by EXHIBITOR, or bodily injury occurring within the confines of Exhibitor's booth, remain the sole and complete responsibility of EXHIBITOR. Except where prohibited by law, the EXHIBITOR and its insurers waive all rights of recovery or subrogation against Shepard and their respective directors, officers, employees, and agents.

Claim(s) for Loss and Payment For Services: Exhibitor agrees that any and all claims for loss or damage shall be submitted to Shepard prior to the conclusion of the show when the alleged loss or damage occurred prior to that time, and in all cases within 30 days of the conclusion of the show. For claim reporting purposes, the "conclusion" of the show shall be construed as the end of the day on which exhibitor must vacate the show site. All claims reported after the 30-day period will be rejected. In no event shall a suit or action be brought against Shepard more than one year after the date the loss or damage occurred. Payment for services may not be withheld. In the event of any dispute between Shepard and the exhibitor relative to any loss or damage claim, the exhibitor shall not be entitled to and shall not withhold payment for Shepard services as an offset against the amount of the alleged loss or damage. Any claim against Shepard shall be considered a separate transaction and shall be resolved on its own merit.

Limits of Liability: If found liable for any loss, Shepard's sole and exclusive maximum liability for loss or damage to Exhibitors materials and Exhibitor's sole and exclusive remedy is limited to \$.50 (USD) per pound per article with a maximum liability of \$100.00 (USD) per item, or \$1,500.00 (USD) per shipment whichever is less. All shipment weights are subject to correction and final charges determined by the actual or re-weighed weight of the shipment. Shepard shall in no event be liable for collateral, exemplary, indirect costs or damages, or loss of sales resulting from, or related to, a claim for loss of or damage to material.

Inbound and Outbound Shipments: Consistent with trade show industry practices, there may be a lapse of time between the delivery of shipment(s) to the booth and the arrival of the exhibitor or his representative. During such time, the materials will be left unattended. Shepard is not, and cannot be, responsible for loss, damage, theft, or disappearances of exhibitor's materials after same have been delivered to the exhibitor's booth. Similarly, there may be a lapse of time between the completion of packing and the actual pick up of exhibitor's materials from the booth for loading onto a carrier. During such time, the materials will be left unattended. Shepard shall not be responsible for loss, damage, theft, or disappearance of exhibitor's materials before same have been picked up for loading after the show. All materials will be checked at the booth at the time of loading using document(s) submitted by the exhibitor and notations of exceptions to conditions of materials or piece counts will be made on said document. Shepard assumes no responsibility for loss, damage, theft, or disappearance of exhibitor's materials after same have been delivered to exhibitor's appointed carrier or agent for transportation after the show. Shepard loads materials onto the carrier's truck under the supervision of the carrier driver who checks and signs for the materials. Shepard assumes no liability for any materials after the carrier assumes custody of materials. If exhibitor's designated carrier fails to show by the move out deadline after a show, Shepard shall have the authority to route exhibitor's shipment via an alternate carrier, or return shipment to a local warehouse for disposition at exhibitor's expense.

Packaging, Crates, and Empty Containers: Shepard shall not be responsible for surface damage to loose or uncrated materials, pad-wrapped, or shrink-wrapped materials. Shepard shall not be responsible for concealed damage, damage to carpets in bags or poly, or damage to materials improperly packed. Shepard shall not be responsible for crates and packaging unsuitable for handling, partially assembled, or having prior damage. Affixing "Empty" storage labels to containers is the sole responsibility of the exhibitor or their representative. All previous labels should be removed. Shepard assumes no responsibility for removal or mis delivery of containers with old labels or incorrect information on labels or for loss or damage to materials stored in containers labeled "empty."



3rd Party Payment Authorization

North Atlanta Home Show

Infinite Energy Arena (Gwinnett Center) - Duluth, Georgia

February 7 - 9, 2020

Deadline **Wednesday, January 8, 2020**

Return this form when a third party (any party other than exhibiting company) should be billed for services.

Event Code:	G175700220
email	atlanta@shepardes.com
phone	(404) 720-8600
fax	(404) 720-8755

Both parties MUST sign this form indicating acceptance; otherwise, request will be denied.
 When a third party is handling your display and/or paying for any services on your behalf, we will agree to this third party arrangement if the following payment is agreed upon and all signatures are properly completed.
 By signing this form, both parties agree and understand that the exhibiting firm is responsible for all charges.
 In the event that the named third party does not make payment by show close, Shepard will be paid by the exhibiting firm on demand at show site.
 The show site invoice may or may not include any outbound services, such as additional material handling, rigging, and/or shipping charges.

Step 1: Provide the Exhibiting Company Contact Information and Signature

Exhibiting Company Name: _____ Booth #: _____

Exhibiting Company Address: _____

Phone: _____

Email Address: _____

Exhibiting Company Authorized Name - Please Print: _____

Signature from Exhibiting Company: _____

Step 2: Check Services Below to Bill to the Third Party

All Services

Booth Cleaning
 Carpet
 Exhibit Rentals
 Installation/Dismantling Labor
 Logistics/Transportation
 Material Handling
 Furniture
 Overhead Rigging/Labor
 Other (please specify): _____

Step 3: Provide Third Party Contact Information

3rd Party Company Name: _____

Contact Name: _____

Address: _____

Phone: _____ Email Address: _____

Step 4: Complete Third Party Credit Card Charge Authorization with Signature

Credit Card Information

(Required for all forms of payment)



Credit Card #: _____

Expiration Date: Month: _____ Year: _____ Security Code: _____

Billing Address: _____

City, ST, Zip: _____

Name on Card: (Please Print) _____

Signature: _____



North Atlanta Home Show

Infinite Energy Arena (Gwinnett Center) - Duluth, Georgia
February 7 - 9, 2020

Due By: Wednesday, January 8, 2020

Event Code: G175700220
email: atlanta@shepardes.com
phone: (404) 720-8600
fax: (404) 720-8755

This form is to be completed by the Exhibitor and returned to Shepard by deadline date noted above.

Exhibiting Company Name

Booth #

Email Address:

An Exhibitor Appointed Contractor (EAC) is a company other than the "general or official" service provider on the show that requires access to your booth during installation and dismantling. The EAC may only provide services in the facility that are not designated by the facility as "exclusive" to a designated provider, or by the event organizer in a contract as an exclusive service for the "general or official: service provided or other third party.

No EAC will be allowed to work in an exhibitor's booth if this EAC form, a valid form of insurance, a third party payment authorization form and an exhibitor payment authorization is not completed by an authorized representative and received by Shepard by the due date indicated above. The Form must be completed for every third party (as well as any other ordering third party ordering or requesting services from Shepard on behalf of exhibitor) at the above event. Multiple booths are not to be listed on one form. If form is not submitted by deadline date, the EAC will not be allowed to perform work in the hall except to supervise the official contractor provided labor.

Exhibitor Appointed Contractor

Contact Name

Street Address

City

Phone #

Description of proposed service for Exhibitor

The EAC hired by the exhibitor must, by the deadline date, provide Shepard with a current Certificate of Insurance with minimum limits of \$500,000 property damage per occurrence, \$1,000,000 personal injury per occurrence, workers compensation aggregate coverage of \$1,000,000 per occurrence, and naming Shepard Exposition Services as the certificate holder for the time period of the event, including move-in and move-out days. Listing Shepard Exposition Services as an additionally insured only will not be accepted, and may prevent EAC from working on the premises. If EAC does not have minimum coverage and proper documentation, they will be subject to employing Shepard Exposition Services for labor services.

The EAC must abide by the rules and regulations of the show and all pertinent union regulations.

EAC employees must wear approved identification badges at all times while in the work area. Badge will be issued at show site to authorized contractor representatives when all requirements have been met.

The EAC must confine its operations to the exhibit area of its clients. No service desks, storage areas or other work facilities will be located anywhere in the facility. Show aisles and public areas are not part of the Exhibitor's booth space.

Solicitation of business by EAC is strictly prohibited. EAC companies discovered soliciting will be removed from the show floor and the exhibitor will not be able to use that EAC for the remainder of the event.

The EAC must have all business licenses, work permits and insurance required by State and City governments and Facility Management before beginning work, and shall provide Show Management with evidence of compliance.

If required, the EAC must be able to provide evidence that it has current and applicable labor contracts and must comply with all labor agreements and jurisdictions. The EAC must not jeopardize the production of the event by any act or practice that would lead to work stoppages, strikes or labor disputes.

EACs agrees to keep all No Freight Aisles clear at all times. If SES is required to rearrange any material situated in a clearly No Freight Aisle, the exhibitor or the EAC depending on billing arrangements will be a charged a 1 hour minimum forklift rental and labor.

Exhibitor Signature:



Relax with our Carefree Logistics!

Shepard Logistics is the official show carrier. Our dedicated team of Logistics Specialists will provide you with personalized and efficient shipping solutions to make sure your freight arrives on time. We make shipping easy and convenient!

Inbound & Outbound Services

- Small Package
- Standard Ground
- Next Day, 2nd Day, and 3rd Day Service levels
- Air Ride
- Flat Bed
- Dedicated Truckload

Shepard Value-Added Services

- Priority empty return for all inbound Shepard Logistics customers
- Transparent quotes with no hidden charges such as reweigh or trade show fees
- Shepard Logistics available 7 days a week
- Late to Warehouse and Late to Show Site Fee waived
- Outbound shrink-wrap at no charge
- Signature Series Material Handling 10% discount to all roundtrip customers

Have a Logistics Question?

Visit Shepard Logistics in your Exhibitor Services Catalog or contact our Logistics team:

1.888.568.8858 | logistics@shepardes.com



Exhibit
Rental



Traffic
Builders



Logistics &
Transportation



Furniture
Rentals



Material Handling
& Ground Rigging



More!



SHIPPING VERSUS MATERIAL HANDLING

WHAT IS SHIPPING?

Shipping is the process of a carrier picking up your items from your office or place of origin and transporting it to the dock of either the advance warehouse or facility dock of your event. It is separate from Material Handling. Exhibitors may use any carrier they want, including Shepard Logistics.

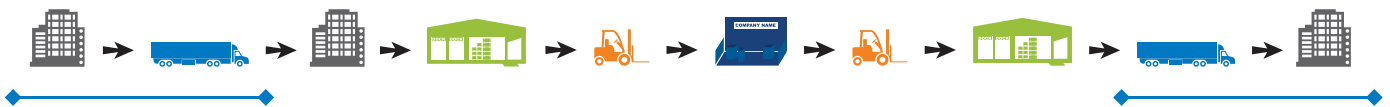

WHAT IS MATERIAL HANDLING?

Material Handling is the process of receiving your shipment from your carrier and managing it through the event cycle. It is a standard tradeshow process and it is a chargeable fee typically based on the weight of your shipment. Don't forget to add Material Handling to your budget!



Material Handling Process:

- Unloading the trade show freight from your carrier once it arrives at the receiving dock.
- Transporting your shipment to your booth space.
- Removing empty shipping containers (boxes, crates, and pallets) from your booth.
- Temporarily storing your empty shipping containers during the show.
- Returning empty shipping containers to your booth once the event is over.
- Transferring the freight back to the loading dock.
- Loading the items into your carrier's delivery vehicle for return shipping.

ONE EASY WAY TO KEEP YOUR CHARGES LOWER?

Consolidate, Consolidate, Consolidate!

Skid items as much as possible so that they are sure to arrive together. Each shipment that arrives at a separate time is assessed the minimum charge. Whether you ship to the advance warehouse or show site it is in your best interest to consolidate as much as possible.



North Atlanta Home Show

Infinite Energy Arena (Gwinnett Center) - Duluth, Georgia

February 7 - 9, 2020

Event Code: G175700220
email: logistics@shepardes.com
phone: (888) 568-8858
fax: (404) 596-5620

Ship Roundtrip with Shepard Logistics and receive a 10% discount on Material Handling*

Discount does not apply to shipments considered small package, local deliveries, "Light Weight" shipments, or shipments over 10,000 lbs. Roundtrip SLS shipping is required to qualify for discount. (35572)

Step 1: Complete Exhibiting company information:

Exhibiting Company Name Booth #

Contact Name Phone # State Zip

Email Address

Step 2: Tell us the Location of items for pick up:

Company

Street Address City State Zip

- Is there a loading dock? Do we need a lift gate on our truck?
Is your building in a residential area? Do we need to go inside your office to pick up your items?
Any thing else we should know about your building

Step 3: Tell us When we are picking it up:

Date Hours of Operation

Step 4: Tell us Where this is going: Advance Warehouse Direct to showsite Tuesday, February 4, 2020

Step 5: Tell us What we are shipping:

Table with 2 columns: Qty, L, W, H, Weight. Items include Crates, Cartons, Cases/trunks, Skids/pallets, Carpet, Monitors, Other, Total.

Step 6: Tell us what Type of Service do you need (how fast do you need it?)

Standard Ground 2nd day Air Next Day Air Other (Truckload, Specialized) Service level may be changed to meet delivery date. Order must be received within 24 hours of requested pick up date

Step 7: After the event is over, are we going to Ship Back to you? YES! No, I will arrange another carrier

Company Booth #

Street Address City State Zip

A credit card must be on file to order Shipping Services. Please complete the Payment Authorization form. Shipping services do not include material handling charges at show site. Material handling fees will be charged to the credit card on file.

Print at least one label for each box. Include the exhibiting company name and booth number. If you are creating your own labels, make sure the same information below is on your labels.

R U S H	
	ADVANCE WAREHOUSE
	TO: _____ (Exhibiting Company Name)
	Booth #: _____
	c/o Shepard Exposition Services
	1790 Marietta Blvd
	Atlanta, GA 30318
	Delivery Hours: M-F, 8-4:00 PM
For: _____	
North Atlanta Home Show	
First day freight can arrive w/o a surcharge: January 8, 2020	
Last day freight can arrive w/o a surcharge: January 28, 2020	

R U S H	
	ADVANCE WAREHOUSE
	TO: _____ (Exhibiting Company Name)
	Booth #: _____
	c/o Shepard Exposition Services
	1790 Marietta Blvd
	Atlanta, GA 30318
	Delivery Hours: M-F, 8-4:00 PM
For: _____	
North Atlanta Home Show	
First day freight can arrive w/o a surcharge: January 8, 2020	
Last day freight can arrive w/o a surcharge: January 28, 2020	

R U S H	
	ADVANCE WAREHOUSE
	TO: _____ (Exhibiting Company Name)
	Booth #: _____
	c/o Shepard Exposition Services
	1790 Marietta Blvd
	Atlanta, GA 30318
	Delivery Hours: M-F, 8-4:00 PM
For: _____	
North Atlanta Home Show	
First day freight can arrive w/o a surcharge: January 8, 2020	
Last day freight can arrive w/o a surcharge: January 28, 2020	

R U S H	
	ADVANCE WAREHOUSE
	TO: _____ (Exhibiting Company Name)
	Booth #: _____
	c/o Shepard Exposition Services
	1790 Marietta Blvd
	Atlanta, GA 30318
	Delivery Hours: M-F, 8-4:00 PM
For: _____	
North Atlanta Home Show	
First day freight can arrive w/o a surcharge: January 8, 2020	
Last day freight can arrive w/o a surcharge: January 28, 2020	

Print at least one label for each box. Include the exhibiting company name and booth number. If you are creating your own labels, make sure the same information below is on your labels.

RUSH

DIRECT TO SHOW

TO: _____
(Exhibiting Company Name)

Booth #: _____

c/o Shepard Exposition Services
Infinite Energy Arena (Gwinnett Center)
6400 Sugarloaf Pkwy, Ste 100
Duluth, GA 30097

For:
North Atlanta Home Show

MUST NOT BE DELIVERED PRIOR TO:
February 4, 2020 @ 8:00 AM

RUSH

DIRECT TO SHOW

TO: _____
(Exhibiting Company Name)

Booth #: _____

c/o Shepard Exposition Services
Infinite Energy Arena (Gwinnett Center)
6400 Sugarloaf Pkwy, Ste 100
Duluth, GA 30097

For:
North Atlanta Home Show

MUST NOT BE DELIVERED PRIOR TO:
February 4, 2020 @ 8:00 AM

RUSH

DIRECT TO SHOW

TO: _____
(Exhibiting Company Name)

Booth #: _____

c/o Shepard Exposition Services
Infinite Energy Arena (Gwinnett Center)
6400 Sugarloaf Pkwy, Ste 100
Duluth, GA 30097

For:
North Atlanta Home Show

MUST NOT BE DELIVERED PRIOR TO:
February 4, 2020 @ 8:00 AM

RUSH

DIRECT TO SHOW

TO: _____
(Exhibiting Company Name)

Booth #: _____

c/o Shepard Exposition Services
Infinite Energy Arena (Gwinnett Center)
6400 Sugarloaf Pkwy, Ste 100
Duluth, GA 30097

For:
North Atlanta Home Show

MUST NOT BE DELIVERED PRIOR TO:
February 4, 2020 @ 8:00 AM



Material Handling Rates

North Atlanta Home Show

Infinite Energy Arena (Gwinnett Center) - Duluth, Georgia
February 7 - 9, 2020

Event Code: G175700220
email atlanta@shepardes.com
phone (404) 720-8600
fax (404) 720-8755

Ship Roundtrip with Shepard Logistics and receive a 10% discount on Material Handling*

Discount does not apply to shipments considered small package, local deliveries, "Light Weight" shipments, or shipments over 10,000 lbs. Roundtrip SLS shipping is required to qualify for discount. (35572)

What is Material Handling?

Material Handling is the unloading and delivery of exhibit freight to the exhibitor's booth on the show floor, the storage of empty containers, the return to booth for packing, and the loading back onto the exhibitor's outbound carrier. This is an automatic service and is billed based on weight. This service, whether used completely or in are part, are billed as a package.

How to Calculate Material Handling Services: The following services whether used completely or in part are offered as a package. When estimating weight, round up to the next 100 lbs. For example: 285 lbs. = 300 lbs./100 lbs. = 3 X RATE = \$ Amount or minimum charge, whichever is greater.

Standard Material Handling Rates: All rates are per 100 pounds with a 200 pound minimum charge. Certified weight tickets are required on all shipments.

Blended Rates: The rates stated are blended to include overtime based on the schedule at publication. Changes in schedule or if your carrier delivers your freight outside of published hours may result in additional fees. Please see Material Handling page for a complete listing of all possible charges.

Important! All Material Handling fees will be automatically billed to the credit card on file!

Advance Warehouse Shipments

First date freight can arrive Wednesday, January 8, 2020
Last date freight can arrive Friday, January 31, 2020

Item	Code	Weight	Price	Total
Crated	35010	_____ x	\$113.58	_____
Special Handling	35036	_____ x	\$147.75	_____

Single pieces over 5000 pounds, machines or uncrated items cannot be accepted at warehouse.

Direct to Showsite Shipments

First date freight can arrive Tuesday, February 4, 2020

Item	Code	Weight	Price	Total
Crated	35030	_____ x	\$115.57	_____
Uncrated	35043	_____ x	\$173.25	_____
Special Handling	35038	_____ x	\$150.25	_____

Large pieces of machinery and uncrated shipments can be accepted at showsite.

Light Weight (Shipments 40 pounds or less)

Item	Code	Weight	Price	Total
Light Weight Shipment	35400	_____ x	\$56.75	_____

Other Material Handling Services

Banding Service per 4x4 skid/pallet	35490	Qty _____	\$75.00
Shrink-wrap Service per 4x4 skid/pallet	35491	Qty _____	\$75.00

Only Shepard personnel are allowed to operate mechanical equipment.

We understand that your calculation is only an estimate. Invoicing will be calculated from actual certified weight ticket or reweigh ticket on inbound material handling receiving report. Adjustments will be made accordingly. Any adjustments to charges must be made at show site. Acceptance of said terms and conditions will be construed when any of the following conditions are met: This Material Handling Agreement (MHA) is signed; Exhibitor's materials are delivered to Shepard's warehouse or to an event site for which Shepard is the Official Show Contractor or an order for labor and/or rental equipment is placed by Exhibitor with Shepard. Please be aware that disposal of exhibit properties is not included as part of your material handling charges. Please contact Shepard for your quoted rates and rules applicable to disposal of your exhibit properties.

All Material Handling charges are billable and will be charged to the credit card on file.

Contact Name _____

Email: _____

Signature: _____

North Atlanta Home Show

Infinite Energy Arena (Gwinnett Center) - Duluth, Georgia

February 7 - 9, 2020

Event Code: G175700220
 email: atlanta@shepardes.com
 phone: (404) 720-8600
 fax: (404) 720-8755

Special Handling Definitions Rate as shown on Material Handling Rate Form, approx. 30%

Shipments received that are packed in a manner as to require additional handling/labor are deemed special handling. Examples of shipments falling into this category would be constricted space unloading, ground unloading, stacked shipments, designated piece unloading, shipment integrity, mixed shipments, no bill of lading or documentation, carpet/pad only shipments.

- Constricted Space - Freight packed in trailer to full capacity. Shipments are not easily accessible because trailer is loaded by cubic space, or top to bottom and side to side.
- Stacked Shipments - Shipments with multiple pieces stacked on top of one another throughout the majority of the truck or trailer requiring unstacking during the unloading process.
- Mixed Shipments - Mixed shipments are shipments that contain a mixture of uncrated and crated materials, and the uncrated portion is minimal deeming the shipment special handling but not uncrated. But in cases where greater than 50% of the load by volume is uncrated the load will be categorized as uncrated.
- Shipment Integrity - Shipments loaded on a carrier in a manner requiring separating or sorting to reestablish the integrity of each shipment.
- Carpet/Pad Only - Carpet and/or pad only shipments are time and labor intensive, and require additional manpower and tools (e.g. carpet poles, flatbed carts or scooters, dollies).
- No Documentation - Shipments received from small package carriers (including, among others, Fed Ex, UPS, & DHL) that are delivered without documentation or bills of lading that require additional sorting, processing, and tools for delivery.
- Designated Piece Unloading - Shipments loaded in such a manner that require the unloading/loading crew to be directed by driver remove items in a particular order, or unloading and reloading items to reach certain pieces behind others remaining on the trailer.

Padded Van Deliveries This applies to van line carriers that transport freight at cubic displacement rates, operate a non-standard dock height equipment, require freight on the truck to be unloaded in a specific order or orientation, or require that freight on the truck be moved to unload the actual delivery.

Disposal Fee

A disposal fee & minimum 1 hr. labor will be charged for all booth materials (booth displays, flooring, etc.) that are left unclaimed after show move-out.

Overtime/Double-time Surcharge: Overtime: 30% Double Time: 50%

Shipments that are moved and/or handled on overtime and/or double time hours will incur a surcharge based on the handling times noted on the receiving/shipping documents. Drivers picking up outbound shipments will be sequenced for loading ONLY after a bill of lading is submitted to the Shepard Service Desk AND the driver has checked in.

Warehouse Overtime/Double-time Surcharge: Overtime: 30% Double Time: 50%

Advanced shipments may be received during straight time hours at the warehouse location, however an overtime/double time surcharge may be applied to an advanced warehouse shipment due to required delivery schedule based on show move-in and move out hours beyond our control. This would also be true if freight was received after hours at the warehouse trapping facility.

Early/Late Shipments to the Warehouse Surcharge: 25% 35003

A surcharge will apply to shipments not arriving within the published dates (refer to Show Information page for dates) for advance warehouse or arriving on show site after show opening. Any shipment arriving to show site after show open will be charged a surcharge.

Uncrated Shipments Rate as shown on Material Handling Rate Form

An additional charge of 50% (or as stated on Material Handling Authorization page) of the applicable material handling charge at the time of delivery shall be charged for all loose, uncrated, or unprotected shipments received at the show site docks. The charge is a one-time charge that includes both move-in and move-out of the show, and is based on the weight of the shipment handled.

Off-Target Deliveries Surcharge: 15% 35004

For targeted shows (exhibitors who received/requested a Targeted Date/Time), a surcharge will apply if shipment is not delivered (or carrier has not checked in) during assigned target date/time.

Marshaling Yard Fee: \$30 per Shipment 35250

Where Shepard Exposition Services as the show contractor must lease space for marshaling yard operations because no space is provided by the facility, Shepard may charge a one time fee per shipment processed inbound and/or outbound through the marshaling yard.

Reweigh of Shipments Fee: \$25.00 per forklift load 35282

An additional charge per forklift load will be applied to shipments that have to be reweighed at the dock due to the lack of a certified weight ticket, or an incorrect or understated weight on a delivery document.

Empty Crate Storage Fee: \$25.00 per piece. 35105

A charge per crate, carton or skid applies when Shepard handles the storage and return of empties from a shipment not received by Shepard and therefore not subject to material handling charges.

Light Weight Shipments

Shipments weighing 40 lbs. or less will qualify for the light weight shipment rate. Shipments exceeding 40 lbs. will be billed standard Material Handling fees at the prevailing show rates. All shipments must have certified weight tickets.

Envelope Deliveries Fee: \$10.50 per envelope 35007

During show hours at the show facility, a charge will apply to receiving and delivering envelope packages to your booth.

Mobile Spotting Fee: \$ 200.00 per round trip 35106

All vehicles must be escorted in and out of building by Shepard personnel.

Shepard Exposition Services is the sole provider of Material Handling Services. Exhibitors or their hired EAC/Carriers may not deliver freight to exhibit spaces or operate any type of mechanical or powered equipment. Material handling is a billable service.

What is material handling (also referred to as drayage)?

Material handling is the process of unloading your freight from your shipping carrier, either at the warehouse or show site, delivering it to your booth, storing your empty containers (empties) if required, returning of your empties at the close of show, and then reloading your freight back onto your shipping carrier.

What is the definition of "freight"? Any exhibit materials shipped or delivered to the advance warehouse or show facility via shipping carrier, POV, or delivery truck.

What is the difference between material handling and shipping?

Shipping is the process of transporting your shipment from its origin to its final destination. Material handling begins at the time your shipment arrives to the docks (please refer to "What is material handling?" for the full definition.) These are 2 different items and are billed differently.

Do I need to order a forklift to unload or reload my freight? No, please do not order a forklift for unloading/reloading of your materials.

What does CWT mean? CWT is an acronym for Century Weight.

What determines how much I'm charged? Charges are based on certified inbound weight ticket included with your shipment as well as the type of service required

How do I calculate material handling charges?

Material handling, whether used completely or in part are offered as a round trip service. When recording weight, round up to the next 100 lbs. EXAMPLE: 285 lbs. = 300 lbs./100 lbs. = 3 X RATE = \$ Amount or minimum charge, whichever is greater.

Will there be any additional charges?

Additional charges may apply. Please review the Material Handling Authorization and Material Handling Additional Services forms included in the manual for all applicable fees

What are Light Weight shipments?

All shipments regardless of carrier that weigh 40 pounds or less. Shipments need to have certified weight tickets or other verifiable weight noted upon delivery. Shipments without certified weight tickets may be subject to special handling or reweigh fees. Packages that arrive separately at different times or days will be billed separately.

All shipments, regardless of carrier, weighing 41 lbs. and up will be billed using the standard material handling rates listed in the kit and billed at a 200 lb. minimum.

How do I calculate my Light Weight shipment? Charges for Light Weight shipments are total shipment weight, per delivery. Any shipment above 40 lbs. will not qualify for this rate. Please be advised that your whole shipment may not arrive to its destination at one time. Therefore you may be charged per each delivery.

What are Crated materials?

Materials delivered that are skidded or in a container that can easily be unloaded/reloaded with no additional handling required.

What are Uncrated materials?

Materials delivered that are loose, pad-wrapped or unskidded without proper lifting bars and/or hooks.

What is Special Handling?

Shipments received that are packed in a manner as to require additional handling/labor are deemed special handling. Examples of shipments falling into this category would be constricted space unloading, ground unloading, stacked shipments, designated piece unloading, shipment integrity, mixed shipments, no bill of lading or documentation, carpet/pad only shipments.

What are Advance Shipments?

All shipments that are addressed to the advance warehouse address (please refer to "Advance Warehouse" shipping labels included in this manual)

Shepard will begin accepting your shipments 30 days prior to first show open day (date may vary depending on show schedule)

The warehouse will receive shipments Monday-Friday, 8:00 AM - 4:00 PM, excluding holidays

Shipments must arrive by advance warehouse deadline date to avoid a late surcharge. (Please refer to the "Show Information" page included with this manual for deadline date.

Crates, cartons, skids, fiber cases, and carpets can be accepted at the warehouse, but DO NOT ship crates weighing over 5,000 lbs., loose/uncrated shipments and/or machinery to warehouse. You must ship those items direct to show site.

All shipments must have a bill of lading or delivery slip indicating number of pieces and weight. Certified weight tickets required

All shipments must be prepaid, no collect on delivery shipments will be accepted.

What are Direct Shipments?

All shipments that are addressed directly to the exhibit facility (please refer to "Direct to Show" shipping labels included in this manual).

Shipments must arrive during published exhibitor move-in times only. Do not ship direct to show site in advance. If delivery cannot be guaranteed to arrive during exhibitor move-in, shipment must go to advance warehouse.

All shipments must have a bill of lading or delivery slip indicating number of pieces and weight. Certified weight tickets required.

Crates weighing over 5,000 lbs. or loose/uncrated shipments must be shipped direct to show site to arrive during exhibitor move-in times.

All shipments must be prepaid, no collect on delivery shipments will be accepted.

What is and why would I need liability insurance?

Accidents happen, therefore, most show organizers and facilities require liability insurance. Please refer to your booth contract for exact minimums required.

Please make sure your materials are covered from the moment they leave your company location to the time they return after the close of the show

If applicable, included in your manual is information and an application for liability insurance and booth coverage can also be purchased to protect your valuable exhibit materials

Outbound Shipping

You must complete a Shepard Material Handling Agreement (MHA) for all outbound shipments. A MHA will be distributed at show site if all services have been paid in full, or you can request one at the customer service desk.

Upon completion of packing and labeling of your materials, complete the bill of lading (MHA) with all required information, and return to the customer service desk. If you have questions on how to complete your bill of lading (MHA), please ask a Shepard customer service representative located at the customer service desk.

If you are NOT using the designated show carrier, you must call your carrier with pick-up information. If your carrier fails to pick up your shipment, Shepard Logistics will either reroute your freight through the carrier of our choice or return to the local warehouse (whichever is indicated on your MHA).

Equipment: Exhibitors or their EACs may not utilize or operate any type of material handling mechanical or powered equipment. If you need assistance, please contact us to order labor and equipment.

North Atlanta Home Show

Infinite Energy Arena (Gwinnett Center) - Duluth, Georgia

February 7 - 9, 2020

Event Code:

G175700220

email

atlanta@shepardes.com

phone

(404) 720-8600

fax

(404) 720-8755

Labor Hours

ST - Straight time: Monday - Friday 8AM - 5PM.

OT - Overtime: Monday - Friday 6AM - 8AM and 5PM - Midnight. Saturdays and Sundays 6AM - Midnight.

DT - Double-time: All hours between Midnight and 6AM. Holidays.

Holidays NY Day, MLK Jr. Day, Memorial Day, Independence Day, Labor Day, Thanksgiving, Friday after Thanksgiving, Christmas Eve, Christmas Day

Cartload services are provided to those exhibitors arriving in privately-owned vehicles and have small hand-carried items that need to be delivered to and from the dock/booth location. Exhibitors may not utilize mechanical or powered equipment to unload their items.

If you arrive with a truck, van, trailer, or truck with trailer filled with exhibit material you will not qualify for this service and will be redirected.

No personal trucks (one (1) ton & over), no rental trucks, trailers, or bobtails will be unloaded through cartload service.

All items must fit on flat bed cart (approximately 3'x4' in size) and weigh less than 200 pounds. If items are designated by Shepard personnel to be too large or too heavy, materials will be billed at regular material handling rates.

Your vehicle must unload on the receiving dock of the exhibit hall. Shepard personnel will direct vehicles. The cart is not authorized to enter or go to any parking structure. There must be two (2) people with the vehicle; one person to go with your product to the booth space and one person to remove your vehicle from the unloading area to the parking area.

Cartload Service includes one laborer, one cart, one trip per rate listed below.

Item	Code	# of Trips	Rate	Total
Dock to Booth ST	35151	_____	\$125.50	_____
Booth to Dock ST	35152	_____	\$125.50	_____
Dock to Booth OT	35153	_____	\$168.25	_____
Booth to Dock OT	35154	_____	\$168.25	_____



Only Shepard personnel are allowed to operate mechanical equipment.

Total Estimate:	\$	_____
NA Tax*:	\$	_____
Amount Due:	\$	_____

No refunds or exchanges once service has been rendered.

Cancellations must be received in writing within 48 hours of 1st day of exhibitor move in.

Company Name: _____ Booth # _____

Contact Name _____

Email: _____

Signature: _____



North Atlanta Home Show

Infinite Energy Arena (Gwinnett Center) - Duluth, Georgia

February 7 - 9, 2020

Event Code: G175700220
email atlanta@shepardes.com
phone (404) 720-8600
fax (404) 720-8755

Displaying a vehicle at the event? (including rolling stock, self-propelled, towed and/or pushed vehicles/machinery.)
All vehicles must be escorted on and off the floor by a Shepard representative.
Shepard charges a round-trip fee, per vehicle, to place a vehicle on the tradeshow floor. Additional charges may apply when additional labor and equipment required.

Step 1: If you have a vehicle, make sure it is shown on the official floorplan by alerting Customer Service or your Event Management.

Step 2: Contact Customer Service to schedule your move in and out. Vehicle placement must be supervised by the Exhibitor.

All vehicles must be removed no later than Monday, February 10, 2020 12:00 PM

Any vehicles left after that time are subject to removal by towing or other means. Exhibitors are responsible for all removal charges.

Important Rules and Regulations

- Battery Cables must be disconnected
Gas Cap must either be taped shut or have a lockable gas cap.
Must contain less than 1/4 tank of gas.
Exhibitor is responsible for checking local Fire Marshal rules and regulations for additional requirements.

Table with 5 columns: Item, Code, Qty, Roundtrip, Total. Row 1: Motorized Unit/Vehicle Spotting, 35106, \$200.00

*Additional fees may apply if mobile spot cannot be driven into place and must be assisted or if scheduled mobile spot time is missed.

No refunds or exchanges once item has been delivered to your booth.
Cancellations must be received in writing within 48 hours of 1st day of exhibitor move in.

Total: \$
NA Tax*: \$
Amount Due: \$

Company Name: _____ Booth # _____
Contact Name _____
Email: _____
Signature: _____



North Atlanta Home Show

Infinite Energy Arena (Gwinnett Center) - Duluth, Georgia
February 7 - 9, 2020

Event Code: G175700220
email atlanta@shepardes.com
phone (404) 720-8600
fax (404) 720-8755

Discount Deadline Friday, January 17, 2020

Order with complete Payment Authorization must be received before Discount
Deadline date to receive discounted pricing.

Labor Hours

ST - Straight time: Monday - Friday 8AM - 5PM.
OT - Overtime: Monday - Friday 6AM - 8AM and 5PM - Midnight. Saturdays and Sundays 6AM - Midnight.
DT - Double-time: All hours between Midnight and 6AM. Holidays.
Holidays NY Day, MLK Jr. Day, Memorial Day, Independence Day, Labor Day, Thanksgiving, Friday after Thanksgiving, Christmas Eve, Chris

Ground Rigging and Forklift Rental

Step 1: Describe the work:

Form with checkboxes for Uncrating Materials, Spotting Equipment, Booth work/ground rigging

Weight of Heaviest Piece: _____
Will you need: [] Straps [] Extended Blades

Step 2: When are we moving it? (times are not guaranteed)

Install Date/Time: _____ Dismantle Date/Time: _____

Step 3: Choose your lift size:

Forklift Rental - Up To 5,000 # Capacity

Table with 6 columns: Code, Item, Qty., Discount, Regular, Amount. Rows for ST, OT, DT Hourly Rental.

Forklift Rental - Up To 20,000 # Capacity

Table with 6 columns: Code, Item, Qty., Discount, Regular, Amount. Rows for ST, OT, DT Hourly Rental.

Forklift Rental - Up To 10,000 # Capacity

Table with 6 columns: Code, Item, Qty., Discount, Regular, Amount. Rows for ST, OT, DT Hourly Rental.

Forklift Rental - Up To 30,000 # Capacity

Table with 6 columns: Code, Item, Qty., Discount, Regular, Amount. Rows for ST, OT, DT Hourly Rental.

Forklift Rental - Up To 15,000 # Capacity

Table with 6 columns: Code, Item, Qty., Discount, Regular, Amount. Rows for ST, OT, DT Hourly Rental.

4 Stage Forklift Rental

Table with 6 columns: Code, Item, Qty., Discount, Regular, Amount. Rows for ST, OT, DT Hourly Rental.

Rate structure includes forklift and (1) operator only.

Minimum crews are based on scope of work and area jurisdiction. Additional labor and groundmen will be billed at the hourly rate.

Rigging Supervisor Rates (per man hour)

Table with 6 columns: Code, Item, Qty., Discount, Regular, Amount. Rows for ST, OT, DT per man hour.

Riggers and Material Handlers (per man hour)

Table with 6 columns: Code, Item, Qty., Discount, Regular, Amount. Rows for ST, OT, DT per man hour.

The minimum charge for labor and equipment is one (1) hour. Labor and equipment thereafter is charged in half (1/2) hour increments.

Only Shepard personnel are allowed to operate mechanical equipment.

Orders cancelled without 48-hour written notice will be charged a one (1) hour cancellation fee.

Submission of this form indicates you read and accept the Payment Policy and Terms & Conditions.

Forklift Estimate _____
NA Tax*: _____
Amount Due: _____

Company Name: _____ Booth # _____
Contact Name _____

Email: _____

Signature: _____



Agility

Fairs & Events

The experts in International Event Logistics

Agility Fairs & Events is the preferred International Freight Forwarder and Customs Broker for Shepard Exposition Services events.

Our complete services include:

- Shipment planning—packaging, documentation, scheduling
- Door pick-up at the overseas origin
- International shipping and Customs clearance at US air/port
- Final delivery to the Shepard advance warehouse or show dock
- Pick-up at the show site dock or Shepard warehouse
- Preparation of export documents
- International shipping and Customs clearance overseas
- Final delivery to the overseas return destination

**Single point of contact
for international shipping
from door to door:**

Agility Fairs and Events
1 100 Tamiami Trail S.
Suite B
Venice, FL 34285
Tel: 714-617-6675
Contact: Kelly O'Neill-Exley
koneill@agility.com
www.agility.com/fairsevents
expousa@agility.com

**Get a free quote for international shipping at:
www.agility.com/en/contact-fairs-events**



www.aglfairslogistics.com/usaebrochure/

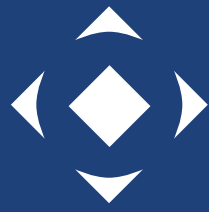

Shepard

FURNISHINGS AND DECOR



Exhibit
Rental



Traffic
Builders



Logistics &
Transportation



Furniture
Rentals



Material Handling
& Ground Rigging



More!

Tables

UNSKIRTED



Display Table
#50040
4' x 24" x 30"
Unskirted



Display Table
#50041
4' x 24" x 42"
Unskirted



Display Table
#50044
6' x 24" x 30"
Unskirted



Display Table
#50045
6' x 24" x 42"
Unskirted



Display Table
#50048
8' x 24" x 30"
Unskirted



Display Table
#50049
8' x 24" x 42"
Unskirted

SKIRTED - 6' & 8' Long Tables are Skirted on 3 Sides. For Skirting on 4 Sides, Please Order 4th Side Skirt.



Display Table
#50042
4' x 24" x 30"
Skirted



Display Table
#50043
4' x 24" x 42"
Skirted



Display Table
#50046
6' x 24" x 30"
Skirted



Display Table
#50047
6' x 24" x 42"
Skirted



Display Table
#50050
8' x 24" x 30"
Skirted



Display Table
#50051
8' x 24" x 42"
Skirted

PEDESTAL & SIDE



30" Natural Pedestal Table
#50706
30" x 36"
Natural Feel Pedestal Table, Maple Top, Black Base



42" Natural Pedestal Table
#50707
42" x 36"
Natural Feel Pedestal Table, Maple Top, Black Base



30" Pedestal Table
#50032
30" x 36"
Pedestal Table, Grey Fleck Top, Chrome Base



42" Pedestal Table
#51089
42" x 36"
Round High Pedestal Table, Grey Fleck Top, Chrome Base



Round Side Table
#50030
18" x 24"



Square Side Table
#50031
18" x 18" x 24"

Chairs

STOOLS



Director's Stool
#51090
Black Fabric, Maple Wood



Natural Feel Stool
#50705
Light Maple Back, Black Fabric Seat



Padded Stool
#50024
Padded Stool with Back, Grey Fabric

CHAIRS WITH ARMS



Director's Stool
#51086
Black Fabric, Maple Wood



Upholstered Arm Chair
#50021
Upholstered Arm Chair, Grey Fabric

CHAIRS WITHOUT ARMS



Natural Feel Chair
#50704
Light Maple Back, Black Fabric Seat



Upholstered Side Chair
#50020
Upholstered Side Chair, Grey Fabric

Display

FOR HANGING



Bag Rack
#50175
9" x 12" x 71"
Adjustable Heights



Coat Rack
#50092
2" x 22" x 69"
Silver



Spiral Garment Rack
#50093
30" x 70"
Silver



2' x 8' Grid with Legs
#50236
2' x 8'
Chrome

Also Available Without
Legs (#50237)



3.5' x 8' Slatwall
#50249
3.5' x 8'
Grey



4' x 8' Peg Board
#50594
4' x 8'
White



6" Hooks for Peg Board
#50104
Silver

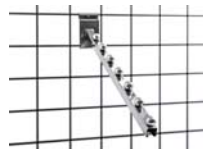

7-Ball Waterfall Grid Attachment
#50242
Silver
Also Available for Slat
Wall #50243

Display

UPRIGHT, CROSSBAR, & DRAPERY



8' High Upright with Base
#50088
Crossbar rented separately



6' - 10' Crossbar
#50349
1 1/4" D



7' - 12' Crossbar
#50348
1 1/4" D



3' High Drape
#50074



8' High Drape
#50074

FOR SIGNS & LITERATURE



Horizontal Tackboard
#50060
4' x 8'
Black Legs, Grey Fabric



Vertical Tackboard
#50061
8' x 4'
Black Legs, Grey Fabric



Literature Rack
#50245
16" x 10" x 59"



Chrome Sign Holder
#50095
Holds 22" x 28" Sign



Floor Easel
#50094
31" x 31" x 64"

SHELVING



4' x 12" Display Shelf
#50296
4' x 12"
White Shelf with Black Bases



6' x 12" Display Shelf
#50297
6' x 12"
White Shelf with Black Bases

BARRIER



Tensa Barrier Stanchion
#50427
Barrier with Black Belt
Barrier 13" x 41"
Black Belt 117"
Rented individually, not a set

OTHER



Natural Feel Wastebasket
#50708
Beige Wastebasket



Wastebasket
#50091



Mini Refrigerator
#50098



Drawing Bowl
#51085



Sand Bag
#51087

*The product photos shown are representative of the products. Actual products and colors may vary from the images shown. Not every item or every color will be available on every event.

Showcase



4' Full View Showcase
#50067

6' Full View Showcase
#50068



4' Quarterview Showcase
#50069

6' Quarterview Showcase
#50070

Flooring

EXPO - 13oz



PREMIUM - 28oz



PLUSH - 50oz

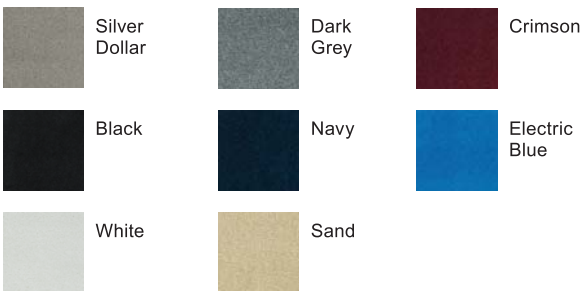

VINYL - Custom Order Only

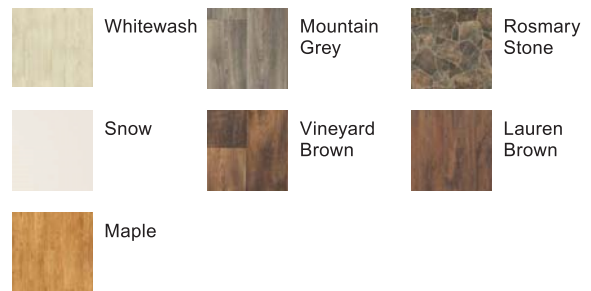

Skirt Color Options

SKIRT



Gold



Blue



Red



Green



Teal



Burgundy



Black



Grey



White

SPANDEX



Blue



Red



Black



White

Drape Color Options



Gold



Blue



Red



Green



Teal



Burgundy



Black



Grey



White



North Atlanta Home Show

Infinite Energy Arena (Gwinnett Center) - Duluth, Georgia

February 7 - 9, 2020

Event Code: G175700220
 email: atlanta@shepardes.com
 phone: (404) 720-8600
 fax: (404) 720-8755

Discount Deadline Friday, January 17, 2020

Order with complete Payment Authorization must be received before Discount
 Deadline date to receive discounted pricing.

Tables

Code	Item	Qty	Color	Discount	Regular	Total
50042	4'L X 30"H X 24"W Skirted Table			\$131.10	\$170.45	
50046	6'L X 30"H 24"W Skirted Table			\$161.10	\$209.45	
50050	8'L X 30"H 24"W Skirted Table			\$204.30	\$265.60	
50043	4'L X 42"H 24"W Skirted Table			\$159.35	\$207.15	
50047	6'L x 42"H 24"W Skirted Table			\$204.05	\$265.25	
50051	8'L x 42"H 24"W Skirted Table			\$240.05	\$312.05	
50052	4th Side Skirt for 30" High Table			\$79.70	\$103.60	
50171	4th Side 42" Skirt for 42" High Table			\$79.70	\$103.60	
50700	6'L X 30"H 24"W Spandex Table Cover			\$239.00	\$310.70	
50040	4'L X 30"H X 24"W UnSkirted Table		na	\$93.40	\$121.40	
50044	6'L X 30"H X 24"W UnSkirted Table		na	\$111.45	\$144.90	
50048	8'L X 30"H X 24"W UnSkirted Table		na	\$131.40	\$170.80	
50041	4'L X 42"H X 24"W UnSkirted Table		na	\$105.20	\$136.75	
50045	6'L x 42"H X 24"W UnSkirted Table		na	\$131.40	\$170.80	
50049	8'L x 42"H X 24"W UnSkirted Table		na	\$146.65	\$190.65	
51089	Pedestal Table,42"H 36"R Grey Fleck Top		na	\$235.40	\$306.00	
50032	Pedestal. Table,30"H 36"R Grey Fleck Top		na	\$220.10	\$286.15	
50030	Round Side Table 24" W X 18" H		na	\$110.80	\$144.05	
50031	Square Side Table 24" W X 18" H		na	\$110.80	\$144.05	
50706	Natural Pedestal Table 30"H X 36" R Maple Top		na	\$287.95	\$374.35	
50707	Natural Pedestal Table 42"H X 36"R Maple Top		na	\$300.20	\$390.25	

Skirt Colors (6' and 8' Skirted Tables have skirts on 3 sides, to have drape on all 4 sides you must order 4th side drape)

Red (01) Green (02) White (03) Gold (04) Blue (05) Black (06) Burgundy (07) Grey (10) Teal (13) Spandex Red (01) White (03) Blue (05) Black (06)

Seating

Code	Item	Qty	Color	Discount	Regular	Total
50020	Side Chair Grey Fabric		na	\$85.20	\$110.75	
50021	Arm Chair Grey Fabric		na	\$116.15	\$151.00	
50024	Stool w/back Grey Fabric		na	\$141.50	\$183.95	
51086	Director's Chair Black Fabric		na	\$87.90	\$114.25	
51090	Director's Stool Black Fabric		na	\$157.30	\$204.50	
50705	Natural Feel Stool Maple Back, Black Fabric Seat		na	\$171.55	\$223.00	
50704	Natural Feel Chair, Maple Back, Black Fabric Seat		na	\$140.90	\$183.15	

Submission of this form indicates you read and accept the Payment Policy and Terms & Conditions.

There are no exchanges or refunds once item has been delivered to your booth. Cancellations must be received in writing within 14 days prior to first exhibitor move in day.

Rental items found and in use in your booth are subject to "Regular" pricing.

Total Furnishings: \$ _____
 6.000% Tax*: \$ _____
 Amount Due: \$ _____

Company Name: _____ Booth # _____

Contact Name: _____

Email: _____

Signature: _____



North Atlanta Home Show

Infinite Energy Arena (Gwinnett Center) - Duluth, Georgia

February 7 - 9, 2020

Event Code: G175700220
 email: atlanta@shepardes.com
 phone: (404) 720-8600
 fax: (404) 720-8755

Discount Deadline Friday, January 17, 2020

Order with complete Payment Authorization must be received before Discount
 Deadline date to receive discounted pricing.

Specialty & Display

Code	Item	Qty	Color	Discount	Regular	Total
50091	Wastebasket		na	\$19.00	\$19.00	
50094	Floor Easel, Chrome		na	\$47.15	\$61.30	
50245	Literature Rack Silver, Glass		na	\$174.00	\$226.20	
50175	Bag Rack, Chrome		na	\$230.40	\$299.50	
50092	Coat Rack, Chrome		na	\$81.80	\$106.35	
50093	Garment Rack, Chrome		na	\$230.40	\$299.50	
50427	Tensabarrier, Per Stem, Black		na	\$97.20	\$126.35	
50095	Sign Holder, 22x28 Chrome		na	\$107.35	\$139.55	
50185	Drawing Bowl, Clear		na	\$43.25	\$56.25	
50296	4' x 12" Display Riser White and Black		na	\$97.35	\$126.55	
50297	6' x 12" Display Riser White and Black		na	\$121.10	\$157.45	
50098	Mini Refrigerator, Approx 3 cubic feet		na	\$367.50	\$477.75	
50067	4' Full View Showcase, White		na	\$868.35	\$1,128.85	
50068	6' Full View Showcase, White		na	\$957.70	\$1,245.00	
50069	4' Quarter View Showcase, White		na	\$868.35	\$1,128.85	
50070	6' Quarter View Showcase, White		na	\$957.70	\$1,245.00	
50060	4' x 8' Horz. Posterboard Grey Fabric		na	\$281.20	\$365.55	
50061	4' x 8' Vert. Posterboard Grey Fabric		na	\$281.20	\$365.55	
50236	Grids 2'x8' w/legs, each		na	\$207.70	\$270.00	
50237	Grid 2'x8' w/o legs, each		na	\$155.55	\$202.20	
50242	7-Ball Waterfall for Grids		na	\$14.30	\$18.60	
50104	6" Hooks (12) for Peg Boards		na	\$45.75	\$59.50	

Drapery-per linear foot, min 5' linear feet rental

Code	Item	Qty	Color	Discount	Regular	Total
50073	8' High drape on a cross bar, per linear foot			\$22.05	\$28.65	
50074	3' High on a cross bar, per linear foot			\$16.35	\$21.25	
50088	8' Upright w/base		na	\$30.45	\$39.60	
52065	3' Upright w/base		na	\$30.45	\$39.60	
50349	6'-10' Crossbar		na	\$20.25	\$26.35	
50348	7'-12' Crossbar		na	\$20.25	\$26.35	
50058	Sateen, per linear foot			\$18.00	\$23.40	

Drape and Sateen Colors Red (01) White (03) (04) Blue (05) Black (06) Burgundy (07) Grey (10)

Submission of this form indicates you read and accept the Payment Policy and Terms & Conditions.

There are no exchanges or refunds once item has been delivered to your booth. Cancellations must be received in writing within 14 days prior to first exhibitor move in day.

Rental items found and in use in your booth are subject to "Regular" pricing.

Total Furnishings: \$ _____
 6.000% Tax*: \$ _____
 Amount Due: \$ _____

Company Name: _____ Booth # _____

Contact Name: _____

Email: _____

Signature: _____

North Atlanta Home Show

Infinite Energy Arena (Gwinnett Center) - Duluth, Georgia

February 7 - 9, 2020

Discount Deadline Wednesday, January 8, 2020

 Order with complete Payment Authorization must be received before Discount
 Deadline date to receive discounted pricing.

 Event Code: G175700220
 email: atlanta@shepardes.com
 phone: (404) 720-8600
 fax: (404) 720-8755

Order must be received 30 days in advance of show move in. 100 sq ft minimum
Step One: Choose the flooring to enhance your design

Step Two: Check the box of your selected color

Step Three: Determine your booth size (length x width = square footage)

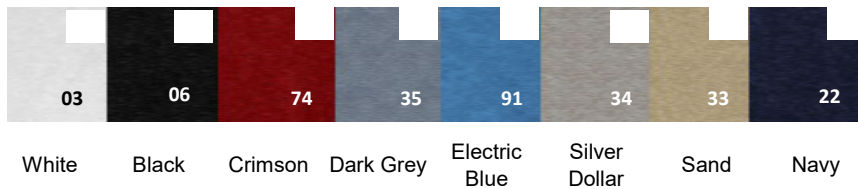
Premium Plush Carpet 50 oz

Code	Sq Ft	Item	Per Sq Ft	Amount
46004		Premium Plush	\$9.30	

Rental includes installation and removal of carpet and visqueen. Minimum 100 sq. ft. required.

Premium Vinyl Flooring

Code	Sq Ft	Item	Per Sq Ft	Amount
46005		Premium Vinyl	\$12.00	

Code	Sq Ft	Item	Per Sq Ft
50712		Light Oak	Call for Quote!
50711		Dark Oak	Call for Quote!

Labor not included in hardwood flooring. Please order labor for the installation of your elevated floor.

Code	Sq Ft	Item	Per Sq Ft	Amount
46007		1/2" Padding for Vinyl	\$4.40	

Elevated Hardwood

Stand above the rest
 with an Elevated
 Hardwood Floor!
 Contact an ESS
 Representative for
 pricing!

 Submission of this form indicates you read and accept the Payment Policy and Terms & Conditions.
 Due to the custom nature of this product, **no refunds or exchanges once item has been ordered.**

 Total Signature Flooring: \$ _____
 6.000% Tax*: \$ _____
 Amount Due: \$ _____

Company Name: _____ Booth # _____

Contact Name: _____

Email: _____

Signature: _____



North Atlanta Home Show

Infinite Energy Arena (Gwinnett Center) - Duluth, Georgia
February 7 - 9, 2020

Event Code: G175700220
email: atlanta@shepardes.com
phone: (404) 720-8600
fax: (404) 720-8755

Discount Deadline Friday, January 17, 2020

Order with complete Payment Authorization must be received before Discount Deadline date to receive discounted pricing.

Step One: Choose the carpet to fit your budget

Step Two: Check the box of your selected color

Step Three: Determine your booth size (length x width = square footage)

Premium Carpet 28 oz, 100% Ultra cut pile with action back or jute backing



Code	Qty	Item	Discount	Regular	Amount
46001		Rental/sqft	\$6.70	\$8.70	
46003		Rental 1000+ sqft	\$5.85	\$7.60	
46002		Purchase sqft	\$16.50	\$21.45	

Rental includes installation and removal of carpet and visqueen. Minimum 100 sq. ft. required.
Minimum 100 sq. ft. is required for purchase carpet. No refunds on cancellations.

Padding & Visqueen Entice attendees to linger in your space with soft, comfortable padding!

Code	Qty	Item	Discount	Regular	Amount
50009		1/2" Padding	\$1.20	\$1.55	
50008		1" Padding	\$2.35	\$3.05	
50010		Visqueen	\$0.35	\$0.45	

Rental includes installation and removal of padding/visqueen. Minimum 100 sq. ft. required.

Expo Carpet 13 oz. 2 Options: Regular and Special Cut!

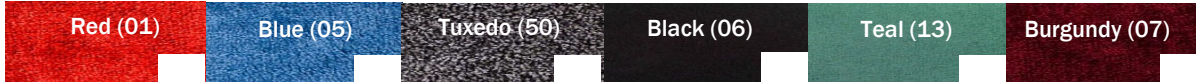

Standard Booth Sizes, Great for inline booths!

Code	Qty	Item	Discount	Regular	Amount
50255		10' x 10'	\$235.15	\$305.70	
50256		10' x 20'	\$438.80	\$570.45	
50257		10' x 30'	\$654.45	\$850.80	
50258		10' x 40'	\$870.15	\$1,131.20	

Variation in dye lot may occur when ordering more than one cut of carpet unless ordered as Special Cut Carpet.

Special Cut, Recommended for Island and large area exhibits!

Code	Qty	Item	Discount	Regular	Amount
50580		0 - 399 sq ft*	\$4.45	\$5.80	
50581		400 - 900 sq ft	\$4.05	\$5.25	
50582		900+ sq ft	\$3.75	\$4.90	

Order Special Cut when it is important that dye lots match. Rental includes installation and removal of carpet and visqueen protective covering. 100 sq ft minimum order.

Prices quoted above include installation and taping of front edge only. All rental carpet is delivered clean to your booth space, but during setup, carpet may become dirty. **Please order cleaning service at least once before show opening.**

Submission of this form indicates you read and accept the Payment Policy and Terms & Conditions.

Total Carpet and Padding: \$ _____

There are no exchanges or refunds once item has been delivered to your booth. Cancellations must be received in writing within 14 days prior to first exhibitor move in day. No refunds on "Special Cut" carpet once order is placed.

6.000% Tax*: \$ _____

Amount Due: \$ _____

Rental items found and in use in your booth are subject to "Regular" pricing.

Company Name: _____ Booth # _____

Contact Name: _____

Email: _____

Signature: _____

TRADESHOW ²⁰²⁰

Furnishings



FEATURING

- Powered Collections
- Modular Seating
- Executive Seating
- Communal Tables
- Bars & Barstools



Inspired Designs for Maximum Engagement

Design an interactive booth that achieves your company vision and encourages attendees to connect, learn, and engage.



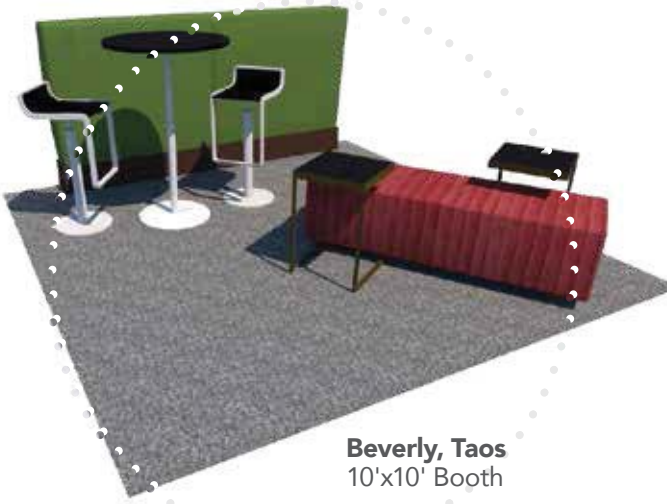

Beverly, Taos
10'x10' Booth



Malba, Beverly
10'x10' Booth



Vibe, Christopher
10'x20' Booth



Blade, Marche
10'x10' Booth

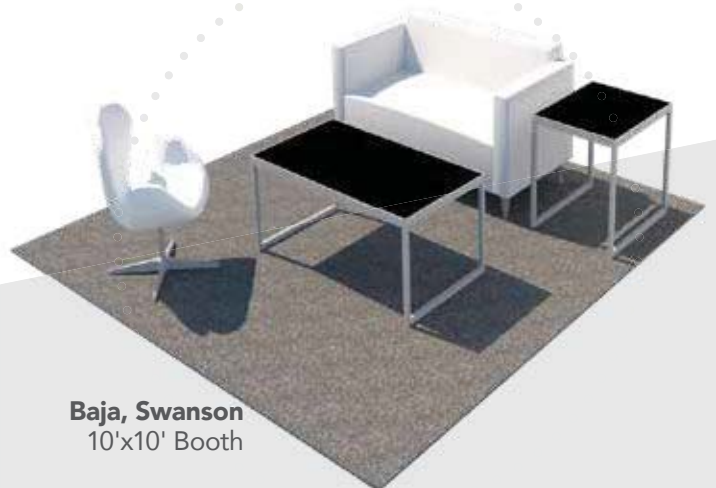

Baja, Swanson
10'x10' Booth

Top 10 Booth Design Tips

Attract, Engage and Inspire.

10.

Provide a Pop!
Colorful furnishings attract attention and help reinforce brand themes.



1.

Spin Around.
Swivel chairs in small spaces maximize functionality and allow you to engage with those all around!



2.

Get Connected.
Communal tables help facilitate networking opportunities and build connections.



9.

Charge it!
Powered tables or seating encourages clients to linger in the booth and recharge.



3.

Creature Comforts.
Design a comfortable "living room" space with soft lounge seating to relax clients and encourage conversation.



8.

Gather Round!
Ottomans styled around a side table create an informal camp fire setting for small group discussions.



4.

Keep it Green.
Don't forget the greenery to warm up your booth environment by bringing nature indoors.



7.

Stay Social.
Stylize furnishings to create shareable moments worthy of Instagram.



6.

Level the field!
Low and casual seating makes clients more comfortable and open to learning.



5.

Demo Down.
Square or circular ottomans are a great way to design small theaters for quick demonstrations.



Roma Powered Seating and Rustique Table Booth
10'x20'

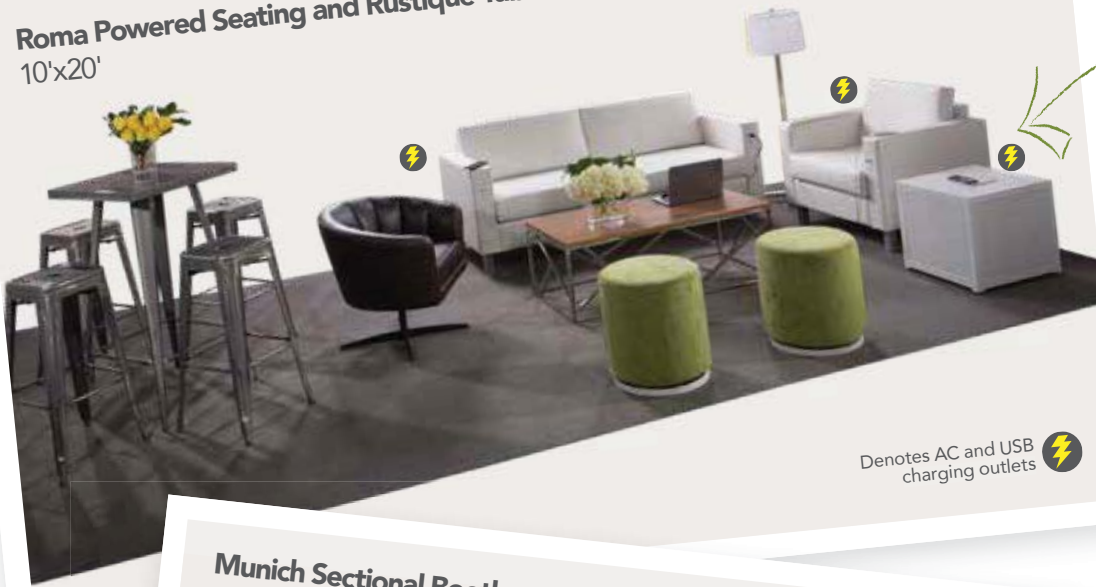

Denotes AC and USB charging outlets ⚡

Keep clients charged with powered seating and add a wireless charging table for attendees without charging cords.

Munich Sectional Booth
10'x10'



Create a comfortable "living room" space with soft lounge seating to relax clients and facilitate conversation.

Malba Conference and Beverly Demonstration Booth
10'x20'



Design multi-functional booths with areas for demonstrations and a place for conferencing.

Powered Seating

Make searching for wall outlets a thing of the past and empower attendees at your next show with functional charging furniture from CORT Events. From pedestals to soft seating and tables, our complete charging collection lets you **Power Up the Possibilities.**

Charge it!

Powered tables or seating encourages clients to linger in the booth and recharge!



CUBPOW
Wireless Charging Table, Powered
(white, AC plug-in) 20"L 20"D 18"H

Roma Powered Chair & Sofa
10'x20'

Roma Collection

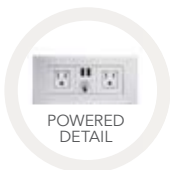

SFAPWR Roma Sofa, Powered
(white vinyl) 78"L 31"D 33"H
CHRPWR Roma Chair, Powered
(white vinyl) 37"L 31"D 33"H

Naples Collection

NPLCHP Naples Chair, Powered (black vinyl) 36"L 30"D 33.25"H
NPLLOP Naples Loveseat, Powered (black vinyl) 62"L 30"D 33.25"H
NPLSOP Naples Sofa, Powered (black vinyl) 87"L 30"D 33.25"H



Banquettes

BNQ417 Full Banquette
w/ Electrical Charging Outlet
(white vinyl) 72"RND 51"H

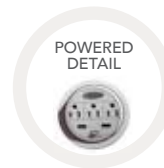

MODULAR SYSTEM Create round banquettes or custom serpentine seating. The Power Banquette system has three AC and two USB plugs built into the center cone so your client will never be left powerless. Center power cone may also be rented as a free standing charging station (BNQTL7).

Powered Tables



A.



B.



C.



D.

Get Connected.
Use communal tables
in your design to facilitate
networking.

E.



(Mobile devices must have Qi wireless charging capability.)

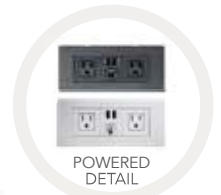

F.



G.

Ventura Bar Tables, Powered (silver frame) 72.25"L 26.25"D 42"H
A) VNTWHT (white top) B) VNTBLK (black top)

Ventura Cafe Tables, Powered (silver frame) 72.25"L 26.25"D 30"H
C) VNTCBK (black top) D) VNTCWH (white top)

E) CUBPOW Wireless Charging Table, Powered (white, AC plug-in) 20"L 20"D 18"H

Sydney Powered Cocktail Tables (brushed steel) 48"L 26"D 18"H
F) C1WP (white top) G) C1YP (black top)



Powered Pedestals

A. | B.



POWERED
DETAIL



POWERED
DETAIL



C. | D.



The flip-top electrical units rotate 180° to let devices charge on or inside the cabinet.

Powered Locking Pedestals

- A) PDL36W** (white)
24"L 24"D 36"H
- B) PDL42W** (white)
24"L 24"D 42"H
- C) PDL36B** (black)
24"L 24"D 36"H
- D) PDL42B** (black)
24"L 24"D 42"H

Powered Desk

B.



POWERED
DETAIL



A.



A) TECH3B Tech Desk, Powered w/3 drawer File Cabinet

(black metal, laminate)
60"L 30"D 30"H

B) TECH Tech Desk, Powered

(black metal, laminate)
60"L 30"D 30"H

Please Note: Client is responsible for providing labor and an electrical power source to the furniture. One 110V power source is required for each charging panel. Two charging units can be daisy chained together. 10A max per charging panel.

Soft Seating Collections



Valencia

VALSOF Sofa (coffee brown velvet) 63"L 30.5"D 31"H
VALCHA Chair (spice orange velvet) 28"L 30.5"D 31"H



Fairfax

FAIRSW Sofa (white vinyl, brushed metal) 62"L 26"D 30"H
FAIRCW Chair (white vinyl, brushed metal) 27"L 26"D 30"H



Allegro CHR002 Chair (blue fabric) 36"L 34.5"D 30"H
SFA002 Sofa (blue fabric) 73"L 34.5"D 30"H



Roma  SFAPWR Sofa, Powered (white vinyl) 78"L 31"D 33"H
CHRPWR Chair, Powered (white vinyl) 37"L 31"D 33"H

Palm Beach
PALSOF Sofa (white vinyl) 69"L 29"D 33"H



Soft Seating



MNCHSC
Munich Sectional 3pc.
(gray fabric)
93.5"L 27"D 28.5"H

CUBPOW ⚡
Wireless Charging Table, Powered
(white, AC plug-in) 20"L 20"D 18"H



POWERED
DETAIL

Munich Booth 10'x20'

Munich



MNCHLV Armless Loveseat
(gray fabric) 45"L 27"D 28.5"H



MNCHCC Corner Chair
(gray fabric) 26"L 27"D 28.5"H



MNCHCH Armless Chair
(gray fabric) 22.5"L 27"D 28.5"H

Creature Comforts.

Create a comfortable "living room" space with soft lounge seating to relax clients and facilitate conversation.



Baja



BCHWHT Chair
(white vinyl) 36"L 30.5"D 28"H



BLVWHT Loveseat
(white vinyl) 61"L 30.5"D 28"H



BSFWHT Sofa
(white vinyl) 86"L 30"D 28"H

Soft Seating Collections



Tangiers

TANCHR Chair (beige textured) 34"L 37"D 36"H
TANLOV Loveseat (beige textured) 57.5"L 37"D 37"H
TANSOF Sofa (beige textured) 78"L 37"D 36"H



Key Largo

KEYCHR Chair (black fabric) 35"L 35"D 34"H
KEYLOV Loveseat (black fabric) 57"L 35"D 34"H
KEYSOF Sofa (black fabric) 79"L 35"D 34"H





Munich

MNCHCH Armless Chair (gray fabric) 22.5"L 27"D 28.5"H
MNCHCC Corner Chair (gray fabric) 26"L 27"D 28.5"H
MNCHLA Loveseat (gray fabric) 45"L 27"D 28.5"H



Baja

BCHWHT Chair (white vinyl) 36"L 30.5"D 28"H
BLVWHT Loveseat (white vinyl) 61"L 30.5"D 28"H
BSFWHT Sofa (white vinyl) 86"L 30"D 28"H



Naples 

NPLCHP Chair, Powered (black vinyl) 36"L 30"D 33.25"H
Also available with standard arm (NPLCHR).
NPLLOP Loveseat, Powered (black vinyl) 62"L 30"D 33.25"H
Also available with standard arms (NPLLOV).
NPLSOP Sofa, Powered (black vinyl) 87"L 30"D 33.25"H
Also available with standard arms (NPLSOF).



Accent Chairs



A.

A) LABREA La Brea Swivel Chair (charcoal gray fabric, chrome) 35"L 27"D 40"H
B) WENCHA Wentworth Swivel Chair (brown vinyl, black) 31"L 24"D 31.5"H



B.

Spin Around.

Swivel chairs in small spaces maximize functionality and allow you to engage with those all around!



C.



D.



E.

C) OCB Key West Chair
(black fabric, wood) 31"L 31"D 31"H
D) BCW Madrid Chair
(white vinyl, chrome) 30"L 30"D 31"H
E) PROGB Pro Executive Guest Chair
(black vinyl, chrome) 24"L 22"D 36"H

Palm Beach Sofa & Swanson Chairs

10'x10' Booth



Swanson

SWAN Swivel Chair
(white vinyl, chrome) 28"L 25"D 30"H



Group Seating

Meeting Chairs

25.5"L 23.5"D 34"H

- A) **OCMTAU** (taupe fabric, wenge)
- B) **OCMWHT** (white vinyl, wenge)
- C) **OCMESP** (espresso vinyl, wenge)



Marina Chairs

17.5"L 19.5"D 35"H

- A) **MARCWH** (white vinyl, brushed metal)
- B) **MARCBK** (black vinyl, brushed metal)
- C) **MARCBR** (brown fabric, brushed metal)
- D) **MARCBE** (ocean blue fabric, brushed metal)
- E) **MARCRD** (red fabric, brushed metal)



A.



B.



C.



D.



E.



F.



G.



H.



I.



J.

- A) CS8 Berlin Chair** (black, white, chrome) 18"L 22"D 32"H
B) CS4 Syntax Chair (black, chrome) 23"L 19"D 32.25"H
C) XCHR Christopher Chair (white vinyl, chrome) 17"L 19"D 35"H
D) SC3 Brewer Chair (onyx, black) 20"L 20"D 32"H
E) RSTDIN Rustique Chair w/arms (gunmetal) 20"L 18"D 31"H
F) ZENCHR Zenith Chair (white, chrome) 18.25"L 22"D 32"H
G) LMCHR Laguna Chair (maple, chrome) 18"L 19"D 34"H

- H) SC10 Razor Armless Chair** (white) 15.5"L 15.5"D 30.5"H
I) BLDCSB Blade Chair (sky blue) 20.5"L 19"D 30.5"H
J) BLDCRD Blade Chair (red) 20.5"L 19"D 30.5"H
K) LUCHCL Lucent Chair (frosted acrylic, chrome) 19.5"L 19.75"D 32.5"H
L) DUET Duet Stack Chair (black, chrome) 21"L 23"D 33"H
M) MALGRN Malba Chair (green, chrome) 20"L 20"D 32"H
N) MALGRY Malba Chair (gray, chrome) 20"L 20"D 32"H



K.



L.



M.



N.

Cafe Seating & Tables



- A) XCHR Christopher Chair**
(white vinyl, chrome) 17"L 19"D 35"H
- B) 30BRHC Hydraulic Cafe Table**
(red top, chrome) 30"RND 29"H
- C) BLDCSB Blade Chair**
(sky blue) 20.5"L 19"D 30.5"H
- D) 30WDHC Hydraulic Cafe Table**
(wood top, chrome) 30"RND 29"H
- E) DUET Duet Stack Chair**
(black, chrome) 21"L 23"D 33"H
- F) 30GSHC Hydraulic Cafe Table**
(green top, chrome) 30"RND 29"H
- G) MALGRN Malba Chair**
(green, chrome) 20"L 20"D 32"H
- H) 30MAHC Madison Hydraulic Cafe Table**
(gray acajou top, chrome) 30"RND 29"H

Style

your exhibit
with cafe sets that
create inviting conference
and meeting areas for
your guests.



- A) MARCBR Marina Chair**
(brown fabric, brushed metal) 17.5"L 19.5"D 35"H
- B) 30WDHC Hydraulic Cafe Table**
(wood top, chrome) 30"RND 29"H
- C) ZENCHR Zenith Chair**
(white, chrome) 18.25"L 22"D 32"H
- D) 30MAHC Madison Hydraulic Cafe Table**
(gray acajou top, chrome) 30"RND 29"H
- E) MALGRY Malba Chair**
(gray, chrome) 20"L 20"D 32"H
- F) 30BEHC Hydraulic Cafe Table**
(blue top, chrome) 30"RND 29"H
- G) LMCHR Laguna Chair**
(maple, chrome) 18"L 19"D 34"H
- H) 30OSHC Hydraulic Cafe Table**
(orange top, chrome) 30"RND 29"H

Ottomans

Vibe Cubes

18"L 18"D 18"H

- A) VIB09 (white vinyl)
- B) VIB10 (black vinyl)
- C) VIB11 (steel blue vinyl)
- D) VIB13 (purple vinyl)
- E) VIB12 (silver vinyl)
- F) VIB04 (red vinyl)
- G) VIB05 (bright yellow vinyl)
- H) VIB15 (taupe vinyl)
- I) VIB02 (blue vinyl)
- J) VIB08 (orange vinyl)
- K) VIB14 (citrus green vinyl)
- L) VIB17 (desert rose vinyl)
- M) VIB16 (spice orange vinyl)
- N) VIB06 (gold/bronze vinyl)
- O) VIB01 (green vinyl)



Squares

Endless Square

34"L 34"D 15"H

- A) END02B (black vinyl, chrome)
- B) END02W (white vinyl, chrome)



A.



B.

Benches

C) WHT12 Half

(white vinyl)
39"L 22"D 18"H

D) REGBEN Regis

(brushed metal)
47"L 15.5"D 16"H



C.



D.

Provide a Pop!

Colorful furnishings
attract attention
and help reinforce
brand themes.

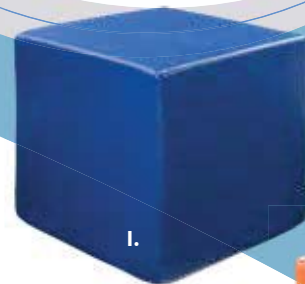
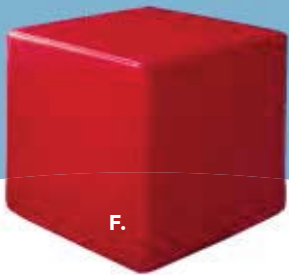
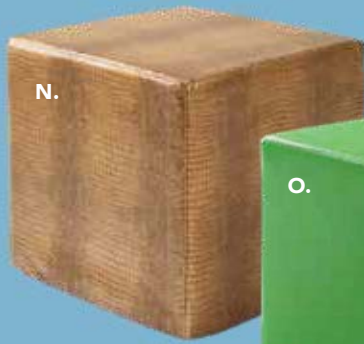

Curves

Endless Curved
60.5"L 37.5"D 15"H
A) END01B
(black vinyl, chrome)
B) END01W
(white vinyl, chrome)



C) BNQ7
Quarter Curve
(white vinyl)
53"L 22"D 18"H
D) BNQR17 Ring
(4 ottoman seats)
(white vinyl)
72"RND 18"H



Beverly

Beverly Bench Ottoman
10'x20' Booth



Demo down.

Rectangular or circular ottomans are a great way to design small theaters for quick demonstrations.



A.



B.



C.



D.



E.



F.



G.

Bench Ottomans

60"L 20"D 18"H

A) BVLYWH (white vinyl)

B) BVLYBK (black vinyl)

C) BVLYGR (gray fabric)

D) BVLYRD (red fabric)

E) BVLYOB (ocean blue fabric)

F) BVLYLN (linen fabric)

G) BVLYBN (brown fabric)

Marche

A.



B.



C.



D.



E.



F.



G.



H.



I.



J.



K.



L.



M.



N.



O.



Swivel Ottomans

17"RND 18"H

- A) MAR001 (white vinyl)
- B) MAR005 (red fabric)
- C) MAR009 (pear yellow fabric)
- D) MAR007 (plum fabric)
- E) MAR010 (blue fabric)
- F) MAR002 (gray fabric)
- G) MAR003 (linen fabric)
- H) MAR004 (raspberry fabric)
- I) MAR008 (meadow green fabric)
- J) MAR011 (orange fabric)
- K) MAR015 (black vinyl)
- L) MAR012 (forest green vinyl)
- M) MAR013 (teal velvet)
- N) MAR014 (distressed brown vinyl)
- O) MAR006 (rose quartz fabric)



Marche Theater 10'x20' Booth

Accent Table Collections

Stay Social.

Stylize furnishings to create shareable moments worthy of Instagram.



Mesa

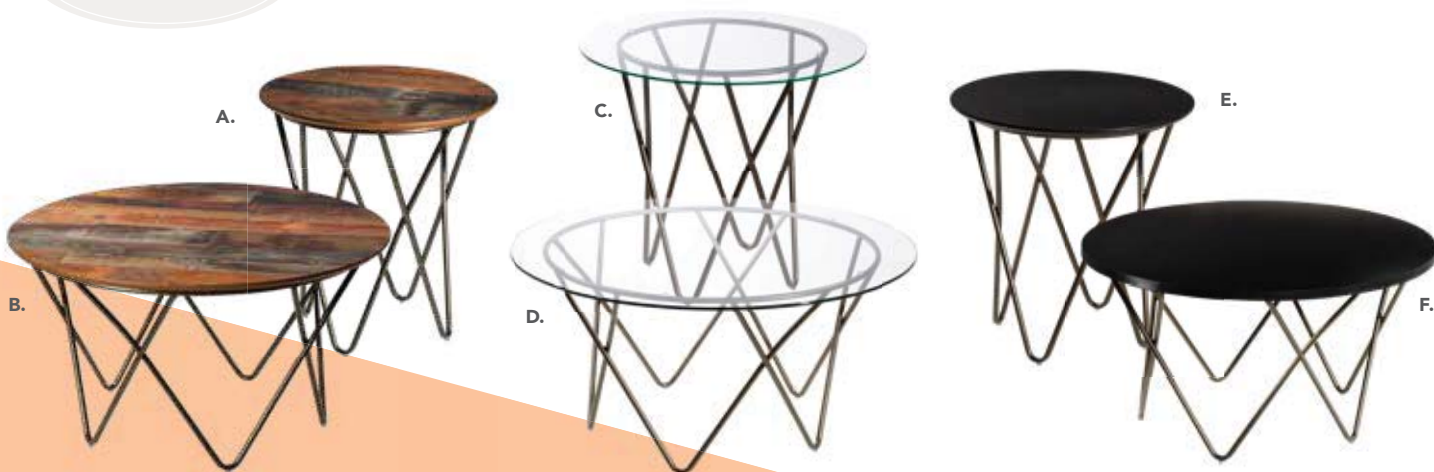

A) MESETW End Table
20.5"RND 21.25"H (wood top, bronze)
B) MESCTW Cocktail Table
32.25"RND 17.25"H (wood top, bronze)

C) MESETG End Table
24"RND 21.25"H (glass top, bronze)
D) MESCTG Cocktail Table
36"RND 17.25"H (glass top, bronze)

E) MESETB End Table
20.5"RND 21.25"H (black top, bronze)
F) MESCTB Cocktail Table
32.25"RND 17.25"H (black top, bronze)

Alondra

Cocktail Table

47" L 24" D 16" H

- A) ALC100 (glass top, chrome)
- B) ALC200 (wood top, chrome)

End Table

20" L 20" D 20" H

- C) ALE100 (glass top, chrome)
- D) ALE200 (wood top, chrome)



Geo

Cocktail Table

50" L 22" D 16" H / 47" L 24" D 17" H

- A) C1C (glass top, chrome)
- B) C1FWB (wood top, black)

End Table

26" L 26" D 20" H / 20" L 20" D 21" H

- C) E1C (glass top, chrome)
- D) E1FWB (wood top, black)



Accent Tables



Taos

Side Tables

15.75"L 15.75"D 24"H

A) TAOBWH (white top, bronze)

B) TAOSBK (black top, bronze)

C) TAOSWD (wood top, bronze)



Sedona

Side Tables

15.75"L 15.75"D 24"H

A) SEDBWH (white top, bronze)

B) SEDBSK (black top, bronze)

C) SEDBWD (wood top, bronze)

Sydney

Cocktail Tables

48"L 26"D 18"H

A) C1W (white top, brushed steel)

C1WP (powered)

B) C1Y (black top, brushed steel)

C1YP (powered)

C) SYDBEC (blue top, brushed steel)

D) SYDWDC (wood top, brushed steel)

End Tables

27"L 23"D 22"H

E) E1W (white top, brushed steel)

F) E1Y (black top, brushed steel)

G) SYDBEE (blue top, brushed steel)

H) SYDWDE (wood top, brushed steel)





Regis

- A) REGBEN Bench Table**
(brushed metal) 47" L 15.5"D 16"H
- B) REGOTT End Table**
(brushed metal) 16" L 15.5"D 16.5"H



Silverado

- C) E1E End Table**
(glass top, chrome) 24" RND 22"H
- D) C1E Cocktail Table**
(glass top, chrome) 36" RND 17"H



Rustic

- E) ETBL E-Table**
(wood) 21" L 15.5"D 27.5"H
- F) TMBTBL Timber Table**
(wood) 16" RND 17"H

Aura

- G) AURA Round Table**
(white metal) 15" RND 22"H



Wireless Charging Table

- H) CUBPOW Wireless Charging Table, Powered**
(white, AC plug-in)
20" L 20"D 18"H

Edge

- I) CUBTBL LED Cube Table**
(plexi top, white plastic)
20" L 20"D 20"H (AC power only)

Bar & Cafe Tables

Style
your exhibit
with **bar and cafe** sets
that create inviting
conference and meeting
areas for your
guests.

1. Choose Your
Base: Black
or Chrome...



Bar Tables

Standard Black Base
30" RND 42"H

VTJ (graphite nebula top)

VTK (maple top)

VTB (red top)

30WH42 (white top)

VTA (Madison/gray acajou top)

30BEBB (blue top)

30WDDB (wood top)

30BKSB (black top)

30AGBB (brushed gunmetal top)

30OSBB (orange top)

30YBBB (brushed yellow top)

30GSBB (green top)

36" RND 42"H

VTW (white top)

VTN (graphite nebula top)

VTP (maple top)

36BKSB (black top)

Bar Tables

Hydraulic Chrome Base

30" RND 45"H

30GRHB (graphite nebula top)

30MTHB (maple top)

30BRHB (red top)

30WHHB (white top)

30MAHB (Madison/gray acajou top)

30BEHB (blue top)

30WDHB (wood top)

30BKHB (black top)

30AGHB (brushed gunmetal top)

30OSHB (orange top)

30YSHB (brushed yellow top)

30GSHB (green top)

36" RND 45"H

36WTHB (white)

36GRHB (graphite nebula)

36MTHB (maple top)

36BKHB (black top)

HDG4FT
Boxwood Hedge, 4'
46"L 9"D 47"H



RSTSQT
Rustique Square
Metal Bar Table
(gunmetal)
23.75"L 23.75"D 41.25"H

LMBAR
Laguna Barstool
(maple, chrome)
18"L 20"D 47"H



2. Then pick a color that suits your design.



Cafe Tables

Standard Black Base

30" RND 29"H

ZTJ (graphite nebula top)

ZTK (maple top)

30WH29 (white top)

ZTB (red top)

ZTA (Madison/gray acajou top)

30BEBC (blue top)

30WDDBC (wood top)

30AGBC (brushed gunmetal top)

30BKSC (black top)

30OSBC (orange top)

30YSBC (brushed yellow top)

30GSBC (green top)

36" RND 29"H

ZTQ (white top)

ZTN (graphite nebula top)

ZTP (maple top)

36BKSC (black top)

Cafe Tables

Hydraulic Chrome Base

30" RND 29"H

30GRHC (graphite nebula top)

30MTHC (maple top)

30BRHC (red top)

30MAHC (Madison/gray acajou top)

30WHHC (white top)

30BEHC (blue top)

30WDHC (wood top)

30AGHC (brushed gunmetal top)

30BKHC (black top)

30OSHC (orange top)

30YSHC (brushed yellow top)

30GSHC (green top)

36" RND 29"H

36WTHC (white top)

36GRHC (graphite nebula top)

36MTHC (maple top)

36BKHC (black top)

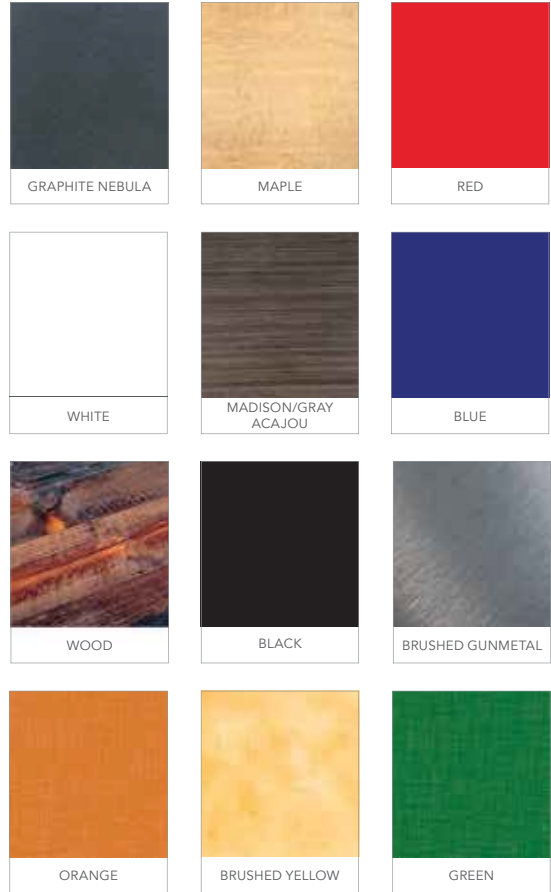

CS4 Syntax Chair

(black, chrome)

23"L 19"D 32.25"H



Barstool Collection

Spin 360°

Use barstools
to maximize client
engagement with those
all around you.

Zoey

15"L 16"D 30-34.75"H

A) BS003 (black, chrome)

B) BS002 (white, chrome)

A.



B.



Lift

15"RND 23-33.5"H

A) ROLLWH (white vinyl, chrome)

B) ROLLRD (red vinyl, chrome)

C) ROLLBL (black vinyl, chrome)

D) ROLLGY (gray vinyl, chrome)



Barstool Collection



Banana

21"L 22"D 41"H

- A) BSS Barstool (black, chrome)
- B) BST Barstool (white, chrome)



Zenith

ZENBAR Barstool

(white, chrome) 19"L 20"D 44"H



Apex

21"L 21"D 33"H

- A) APS08 Barstool (black vinyl, silver)
- B) APS59 Barstool (red vinyl, silver)
- C) APS75 Barstool (white vinyl, silver)
- D) APS12 Barstool (blue ultra suede, silver)





A.



B.



C.

A) BSC Oslo Barstool

(white, chrome) 17"L 20"D 45"H

B) XBAR Christopher Barstool

(white vinyl, chrome) 19"L 15"D 41"H

C) BS001 Shark Barstool

(white, chrome) 22"L 19"D 34-44"H

D) BSR Syntax Barstool

(black, chrome) 23"L 19"D 43.25"H

E) RSTSTL Rustique Barstool

(gunmetal) 13"L 13"D 30"H

F) LUBSCL Lucent Barstool

(frosted acrylic, chrome)

22"L 22.5"D 45.5"H

G) LMBAR Laguna Barstool

(maple, chrome) 18"L 20"D 47"H



D.



E.



F.



G.

Blade

20.5"L 20"D 40.5"H

H) BLDBRD Barstool (red)

I) BLDBSB Barstool (sky blue)



H.



I.

Office Essentials





Create
comfortable
productive environments
in your booth or temporary
show office with on-trend
furnishings that reflect
your sense of
style.

Conference Tables

42" Round Conference Table 42" RND 29"H

- A) CONF42** (white top, black)
- B) CB1** (graphite nebula top, black)
- C) CB8** (Madison/gray acajou top, black)
- D) 42BKCT** (black top, black)



Madison

(gray acajou top, chrome)

- E) MADC05 5' Table** 60"L 48"D 29"H
- F) MADC08 8' Table** 96"L 60"D 29"H
- G) MADC10 10' Table** 120"L 48"D 29"H



H.



G.

I.

- H) CUPCHA Cupertino Mid Back Chair**
(black vinyl, chrome) 27"L 30.5"D 40-43"H Adjustable.
- I) GENCHA Genesis Chair**
(black fabric, black) 27.5"L 27.5"D 40-43.5"H Adjustable.

Table Side.

Incorporate conference tables to facilitate booth meetings and new connections.

Atomic Round Tables (glass, chrome)
42ATO 42"RND 30"H
36ATO 36"RND 30"H



PROGB
Pro Guest Chair
 (black vinyl)
 24"L 22"D 36"H



A.

B.

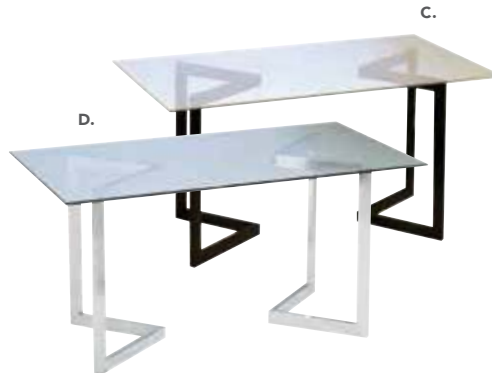

C.

D.

Geo Rounded Square Tables
 42"L 42"D 29"H
A) CE1 (glass top, chrome)
B) CF1 (glass top, black)

Geo Rectangular Tables
 60"L 36"D 29"H
C) CF2 (glass top, black)
D) CE2 (glass top, chrome)



E.

F.



G.

H.

E) MERLIN Merlin Multi Use Table
 (gray top, black)
 46"L 29"D 30"H
F) WD3 Work Table
 (white top, white)
 48"L 24"D 30"H

Conference Tables
 (graphite nebula top, black)
G) CB3 8'
 96"L 48"D 29"H
H) CB2 6'
 72"L 42"D 29"H



I. J.



K.

Conference Tables
 (granite top, black)
I) C508GR 8'
 96"L 44"D 29"H
J) CT10GR 10'
 120"L 46"D 29"H
K) CT06GR 6'
 72"L 36"D 29"H

Executive Seating & Desks

Cupertino



CUPCHA Mid Back Chair
(black vinyl, chrome)
27"L 30.5"D 40-43"H
Adjustable height

Pro High Back



Executive Chairs
25"L 24"D 45-48"H
Adjustable height
A) PROEXE (white vinyl, chrome)
B) PROEXB (black vinyl, chrome)

Pro Mid Back



Executive Chairs
24"L 22"D 36.75-39.75"H
Adjustable height
C) PROMID (white vinyl, chrome)
D) PROMDB (black vinyl, chrome)

Pro Guest



PROGB Executive Chair
(black vinyl, chrome)
24"L 26"D 36"H

Task



TASKST Stool
(black fabric, black)
27.5"L 27.5"D 32.75"-40.25"H
Adjustable height

Genesis



GENCHA Chair
(black fabric, black)
27.5"L 27.5"D 40-43.5"H
Adjustable height

Madison

- A) JD8 Executive Desk (gray acajou) 60"L 30"D 29"H
- B) CR8 Credenza (gray acajou) 60"L 20"D 29"H
- C) BC8 Bookcase (gray acajou) 36"L 12"D 72"H

A. DESK FRONT



DESK BACK



C.



B. CREDENZA FRONT



CREDENZA BACK



Tech Desk

- A) TECH3B Desk, Powered, w/3 Drawer File Cabinet (black top, black metal) 60"L 30"D 30"H
- B) TECH Desk, Powered (black top, black metal) 60"L 30"D 30"H
- C) TECH3 3 Drawer File Cabinet on Castors (black top, black metal) 16"L 20"D 28"H

A. 

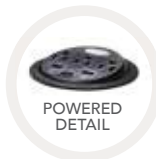

B. 



C.



Ventura

Powered & Communal Tables



Table Top Options
Colors not available in all table options. Please check options listed.

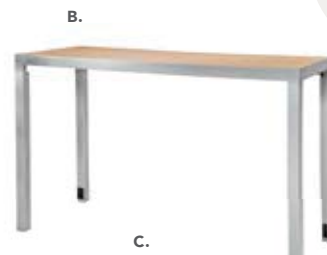

Powered Bar Tables
72.25"L 26.25"D 42"H
(silver frame)

A) VNTBLK (black top)
VNTWHT (white top)

Communal Bar Tables
72.25"L 26.25"D 42"H
(silver frame)

Maple Top
B) VNTMNP (solid)
VNTBMW (grommets)

White Top
C) VNTBWW (grommets)
VNTWNP (solid)

Black Top
VNTBNP (solid)

Draw A Crowd.
Communal tables keep attendees charged while encouraging networking and genuine connections.

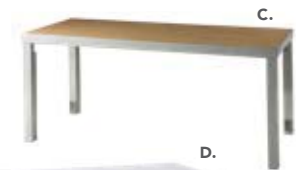

Powered Cafe Tables
72.25"L 26.25"D 30"H
(silver frame)

A) VNTCBK (black top)
B) VNTCWH (white top)

Communal Cafe Tables
72.25"L 26.25"D 30"H
(silver frame)

Maple Top
C) VNTCMN (solid)
VNTCMW (grommets)

White Top
D) VNTCWW (grommets)
VNTCWN (solid)

Black Top
E) VNTCBN (solid)



Office Accessories & Decor



A.



B.



LED light available in white, red, green, blue and rolling color.



C.



D.

Mason Lamps (brushed silver)

A) LA15 Floor Lamp

18" RND 55"H

B) LA14 Table Lamp

16" RND 26"H

C) CUBL20

Edge LED Cube Ottoman

(white plastic)

20"L 20"D 20"H

(AC power only)

D) CUBTBL

Edge LED Cube Table

(plexi top, white plastic)

20"L 20"D 20"H

(AC power only)

Go Biophilic

It's easy to be green.
Just add greenery to your booth environment
for a warm and natural feel.



A.



B.



C.

A) PSHCCS

Posh Shelving

(chrome, acrylic)

36"L 18"D 72"H

B) HDG7FT

Boxwood Hedge, 7'

36.5"L 12"D 84"H

C) HDG4FT

Boxwood Hedge, 4'

46"L 9"D 47"H

Midtown

Counter & Bar

HDG7FT
Boxwood Hedge, 7'
 36.5"L 12"D 84"H



Midtown Powered Counter
 60"L 18"D 42"H (taupe glass top, pewter)
MTCPUL (unlighted)
MTCLPI (lighted with plug-in)

Metallic pewter gray curved counter with taupe-colored glass top features two AC & three USB charging outlets, locking storage cabinet and two shelves.



BLDBSB Blade Barstool
 20.5"L 20"D 40.5"H
 (sky blue)

A.



Midtown Bar
 60"L 18"D 42"H (taupe glass top, pewter)
A) MTBUUL (unlighted)
B) MTBLPI (lighted with plug-in)

Metallic pewter gray curved bar with taupe-colored glass top features locking cabinet for storage and two shelves.



(back)

B.



(lit-blue)



(lit-red)



(lit-green)



(lit-white)



Cocktail and Occasional Tables

North Atlanta Home Show

Infinite Energy Arena (Gwinnett Center) - Duluth, Georgia

February 7 - 9, 2020

Discount Deadline Friday, January 17, 2020

Order with complete Payment Authorization must be received before Discount
Deadline date to receive discounted pricing.

Event Code: G175700220
email: atlanta@shepardes.com
phone: (404) 720-8600
fax: (404) 720-8755

Cocktail Tables

Qty.	Item	Discount	Regular	Amount
	C1E-Silverado	\$347.40	\$451.60	
	ALC100-Alondra, Glass/Chrome	\$418.75	\$544.40	
	ALC200-Alondra, Wood/Chrome	\$418.75	\$544.40	
	C1FWB-Geo, Wood/Black	\$366.40	\$476.30	
	C1C-Geo Rect., Glass/Chrome	\$314.05	\$408.25	
	MESCTB-Mesa Cocktail Table Black top	\$242.55	\$315.30	
	MESCTG-Mesa Cocktail Table Glass top	\$242.55	\$315.30	
	MESCTW-Mesa Cocktail Table Wood top	\$242.55	\$315.30	
	C1W-Sydney, White	\$352.10	\$457.75	
	C1WP-Sydney White, Powered!	\$447.30	\$581.50	
	C1Y-Sydney, Black	\$352.10	\$457.75	
	C1YP-Sydney Black, Powered!	\$447.30	\$581.50	
	REGBEN-Regis Bench Table	\$359.25	\$467.05	
	SYDBEC-Sydney Cocktail Table	\$356.90	\$463.95	
	SYDWDC-Sydney Cocktail Table	\$324.45	\$421.80	

Occasional End Tables

Qty.	Item	Discount	Regular	Amount
	E1E-Silverado	\$330.70	\$429.90	
	ALE100-Alondra, Glass/Chrome	\$302.20	\$392.85	
	ALE200-Alondra, Wood/Chrome	\$302.20	\$392.85	
	E1FWB-Geo, Wood/Black	\$318.85	\$414.50	
	E1C-Geo, Glass/Chrome	\$309.35	\$402.15	
	MESETB-Mesa End Table, Black top	\$160.25	\$208.35	
	MESETG-Mesa End Table, Glass top	\$160.25	\$208.35	
	MESETW-Mesa End Table, Wood top	\$160.25	\$208.35	
	E1W-Sydney, White	\$318.85	\$414.50	
	E1Y-Sydney, Black	\$318.85	\$414.50	
	CUBTBL-Edge LED Cube	\$247.45	\$321.70	
	AURA End Table	\$180.80	\$235.05	
	ETBL-E Table, Wood	\$223.65	\$290.75	
	TMBTBL Timber Table, Wood	\$214.15	\$278.40	
	REGOTT-Regis End Table	\$264.15	\$343.40	
	CUBPOW-Wireless Chrg Tbl, Powered!	\$538.60	\$700.20	
	SYDBEE - Sydney End Table	\$313.65	\$407.75	
	SYDWDE-Sydney End Table	\$313.65	\$407.75	

Submission of this form indicates you read and accept the Payment Policy and Terms & Conditions.

Total Exec Tables Furnishings: \$ _____

There are no exchanges or refunds once item has been delivered to your booth. Cancellations must be received in writing within 14 days prior to first exhibitor move in day.

6.000% Tax*: \$ _____

Amount Due: \$ _____

Rental items found and in use in your booth are subject to "Regular" pricing.

Company Name: _____ Booth # _____

Contact Name _____

Email: _____

Signature: _____



North Atlanta Home Show

Infinite Energy Arena (Gwinnett Center) - Duluth, Georgia

February 7 - 9, 2020

Event Code: G175700220
 email: atlanta@shepardes.com
 phone: (404) 720-8600
 fax: (404) 720-8755

Discount Deadline Friday, January 17, 2020

Order with complete Payment Authorization must be received before Discount Deadline date to receive discounted pricing.

Styles and Shapes

Qty.	Item	Discount	Regular	Amount
	END02B-Square, Black Leather	\$328.35	\$426.85	
	END02W-Square, White Leather	\$328.35	\$426.85	
	END01B-Curved, Black Leather	\$523.45	\$680.50	
	END01W-Curved, White Leather	\$523.45	\$680.50	
	CUBL20-Edge Lighted Cube	\$247.45	\$321.70	
	WHT12-Half Bench, White Vinyl	\$471.10	\$612.45	
	BNQ7-Quarter Curve, White Vinyl	\$616.25	\$801.15	
	BNQR17-Ottoman Ring, White Vinyl	\$2,208.00	\$2,870.40	
	REGBEN Regis Bench, Brushed Metal	\$359.25	\$467.05	

Beverly Bench

Qty.	Item	Discount	Regular	Amount
	BVLYBK Bev Bench Black Vinyl	\$504.40	\$655.70	
	BVLYBN Bev Bench Brown Fabric	\$504.40	\$655.70	
	BVLYGR Bev Bench Grey Fabric	\$504.40	\$655.70	
	BVLYLN Bev Bench Linen Fabric	\$504.40	\$655.70	
	BVLYOB Bev Bench Ocean Fabric	\$504.40	\$655.70	
	BVLYRD Bev Bench Red Fabric	\$504.40	\$655.70	
	BVLYWH Bev Bench White Vinyl	\$504.40	\$655.70	

Marche Swivel

Qty.	Item	Discount	Regular	Amount
	MAR010-Marche Swivel, Blue	\$233.15	\$303.10	
	MAR002-Marche Swivel, Grey	\$233.15	\$303.10	
	MAR003-Marche Swivel, Linen	\$233.15	\$303.10	
	MAR008-Marche Swivel, Mdw Grn	\$233.15	\$303.10	
	MAR009, Marche Swivel, Pear	\$233.15	\$303.10	
	MAR007-Marche Swivel, Plum	\$233.15	\$303.10	
	MAR004-Marche Swivel, Raspberry	\$233.15	\$303.10	
	MAR005-Marche Swivel, Red	\$233.15	\$303.10	
	MAR006-Marche Swivel, Rose Qtz	\$233.15	\$303.10	
	MAR001-Marche Swivel, White	\$233.15	\$303.10	

Vibes

Qty.	Item	Discount	Regular	Amount
	VIB01-Vibe Cube, Green	\$176.10	\$228.95	
	VIB02-Vibe Cube, Blue	\$176.10	\$228.95	
	VIB04-Vibe Cube, Red	\$176.10	\$228.95	
	VIB05-Vibe Cube, Yellow	\$176.10	\$228.95	
	VIB06-Vibe Cube, Gold/Bronze	\$176.10	\$228.95	
	VIB08-Vibe Cube, Orange	\$176.10	\$228.95	
	VIB09-Vibe Cube, White Wtrproof	\$176.10	\$228.95	
	VIB10-Vibe Cube, Black Wtrproof	\$176.10	\$228.95	
	VIB11 Vibe Cube, Steel Blue Vinyl	\$176.10	\$228.95	
	VIB12 Vibe Cube, Silver Vinyl	\$176.10	\$228.95	
	Vibe13-Vibe Cube, Purple Vinyl	\$176.10	\$228.95	
	Vibe16- Vibe Cube, Spice Orange	\$176.10	\$228.95	

Submission of this form indicates you read and accept the Payment Policy and Terms & Conditions.

There are no exchanges or refunds once item has been delivered to your booth. Cancellations must be received in writing within 14 days prior to first exhibitor move in day.

Rental items found and in use in your booth are subject to "Regular" pricing.

Total Ottomans: \$ _____
 6.000% Tax*: \$ _____
 Amount Due: \$ _____

Company Name: _____ Booth # _____

Contact Name _____

Email: _____

Signature: _____



North Atlanta Home Show

Infinite Energy Arena (Gwinnett Center) - Duluth, Georgia

February 7 - 9, 2020

Event Code: G175700220
 email: atlanta@shepardes.com
 phone: (404) 720-8600
 fax: (404) 720-8755

Discount Deadline Friday, January 17, 2020

Order with complete Payment Authorization must be received before Discount
 Deadline date to receive discounted pricing.

Sofas and Sectionals

Qty.	Item	Discount	Regular	Amount
	MNCHSC Munich Sectional, 3 pc	\$2,324.60	\$3,022.00	
	SFA002- Allegro Sofa	\$875.60	\$1,138.30	
	NPLSOF-Naples Sofa, Black Vinyl	\$1,046.90	\$1,360.95	
	VALSOF- Valencia Sofa	\$557.15	\$724.30	
	TANSOF-Tangiers Sofa, Beige	\$830.40	\$1,079.50	
	KEYSOF-Key Largo Sofa	\$592.45	\$770.20	
	FAIRSW-Fairfax Sofa	\$597.20	\$776.35	
	BSFWHT-Baja Sofa	\$1,059.85	\$1,377.80	

Accent Chairs

Qty.	Item	Discount	Regular	Amount
	SWAN-Swanson Swivel, White Vinyl	\$447.30	\$581.50	
	OCB-Key West Tub, Black	\$497.30	\$646.50	
	BCW-Madrid Chair, White	\$935.10	\$1,215.65	
	LABREA-La Brea Swivel Chair	\$513.90	\$668.05	
	VALCHA Valencia Chair	\$374.85	\$487.30	
	MNCHCC Munich Corner Chair	\$706.65	\$918.65	
	MNCHCH Munich Armless Chair	\$582.90	\$757.75	
	OCH Madrid Chair, Black	\$935.10	\$1,215.65	
	WENCHA-Wentworth Chair	\$410.95	\$534.25	

Loveseats

Qty.	Item	Discount	Regular	Amount
	KEYLOV-Key Largo Loveseat	\$459.20	\$596.95	
	TANLOV Tangiers Loveseat	\$866.05	\$1,125.85	
	BLVWHT Baja Loveseat White Vinyl	\$996.90	\$1,295.95	
	MNCHLV- Munich Armless Loveseat	\$1,035.00	\$1,345.50	
	NPLLOV- Naples Loveseat, Blk Vinyl	\$880.30	\$1,144.40	

Meeting Chairs

Qty.	Item	Discount	Regular	Amount
	OCMTAU-Meeting Chair, Taupe	\$342.60	\$445.40	
	OCMWHT-Meeting Chair, White	\$314.05	\$408.25	
	OCMESP-Meeting Chair, Espresso	\$347.40	\$451.60	

Club Chairs

Qty.	Item	Discount	Regular	Amount
	BCHWHT Baja Chair, White Vinyl	\$680.50	\$884.65	
	NPLCHR-Naples Chair, Black Vinyl	\$730.45	\$949.60	
	TANCHR-Tangiers Chair, Beige	\$540.10	\$702.15	
	CHR002-Allegro Chair	\$613.90	\$798.05	
	KEYCHR-Key Largo Chair	\$392.60	\$510.40	
	FAIRCW-Fairfax Chair	\$430.65	\$559.85	

Modular System

Qty.	Item	Discount	Regular	Amount
	BNQ417-Full Banquette- Powered!	\$2,871.80	\$3,733.35	
	BNQR17-Ottoman Ring, White Vinyl	\$2,208.00	\$2,870.40	
	BNQ7-Quarter Curve, White Vinyl	\$616.25	\$801.15	
	BNQTL7- Center Cone, White Vinyl	\$906.50	\$1,178.45	
	WHT12-Half Bench, White Vinyl	\$471.10	\$612.45	

Powered Seating

Qty.	Item	Discount	Regular	Amount
	CHRPWR- Roma Chair, powered	\$792.35	\$1,030.05	
	SFAPWR-Roma Sofa, powered	\$1,275.35	\$1,657.95	
	NPLCHP-Naples Chair, powered	\$792.35	\$1,030.05	
	NPLSOP-Naples Sofa, powered	\$1,275.35	\$1,657.95	
	NPLLOP-Naples Loveseat, powered	\$1,096.90	\$1,425.95	

Submission of this form indicates you read and accept the Payment Policy and Terms & Conditions.

There are no exchanges or refunds once item has been delivered to your booth. Cancellations must be received in writing within 14 days prior to first exhibitor move in day.

Rental items found and in use in your booth are subject to "Regular" pricing.

Total Soft Seating: \$ _____
 6.000% Tax*: \$ _____
 Amount Due: \$ _____

Company Name: _____ Booth # _____

Contact Name _____

Email: _____

Signature: _____



Conference Tables and Group Seating

North Atlanta Home Show

Infinite Energy Arena (Gwinnett Center) - Duluth, Georgia

February 7 - 9, 2020

Discount Deadline Friday, January 17, 2020

Order with complete Payment Authorization must be received before Discount Deadline date to receive discounted pricing.

Event Code:

G175700220

email

atlanta@shepardes.com

phone

(404) 720-8600

fax

(404) 720-8755

Conference Tables

Group & Guest Seating

Qty.	Item	Discount	Regular	Amount	Qty.	Item	Discount	Regular	Amount
	CF2-Geo Table, Black	\$563.90	\$733.05			Duet-Black, Chrome	\$80.90	\$105.15	
	CE1-Geo Table, Sq. Chrome	\$397.30	\$516.50			RSTDIN-Rustique w/ arms, Gunmetal	\$164.15	\$213.40	
	CF1-Geo Table, Sq. Black	\$397.30	\$516.50			CS8-Berlin Chair, Black	\$159.40	\$207.20	
	CE2-Geo Table, Chrome	\$563.90	\$733.05			XCHR-Christopher Chr, White Vinyl	\$130.90	\$170.15	
	CB2-6' Graphite Table	\$592.45	\$770.20			SC10 Razor Chair	\$97.55	\$126.80	
	CB3-8' Graphite Table	\$697.15	\$906.30			SC3-Brewer Chair, Onyx	\$218.85	\$284.50	
	CB1-42" Round, Graphite Nebula	\$480.65	\$624.85			LMCHR-Laguna Chair, Maple/Chrome	\$185.60	\$241.30	
	C508GR-8', Granite	\$697.15	\$906.30			MALGRY-Malba Chair, Grey	\$142.75	\$185.60	
	CT10GR-10', Granite	\$1,046.90	\$1,360.95			MALGRN-Malba Chair, Green	\$142.75	\$185.60	
	CT06GR-6', Granite	\$592.45	\$770.20			CS4-Syntax Chair, Black/Chrome	\$259.35	\$337.15	
	PWRUSB-Powered Table Module	\$95.20	\$123.75			ZENCHR-Zenith Chair-White/Chrome	\$209.35	\$272.15	
	CB8-42" Round Madison, Grey	\$424.85	\$552.30			BLDCRD-Blade Chair	\$84.35	\$109.65	
	MADC10-10' Madison, Grey	\$1,201.55	\$1,562.00			BLDCSB-Blade Chair	\$84.35	\$109.65	
	MADC05-5' Madison, Grey	\$601.95	\$782.55			LUCHCL-Lucent Chair	\$227.10	\$295.25	
	MADC08-8' Madison, Grey	\$1,201.55	\$1,562.00			MARCBE-Marina Chair, Ocn Blue	\$183.85	\$239.00	
	CONF42-42" Round, White lam	\$480.65	\$624.85			MARCBK-Marina Chair, Black Vnyl	\$183.85	\$239.00	
	36ATO Atomic 36" Round, Glass	\$397.30	\$516.50			MARCBR-Marina Chair, Brown	\$183.85	\$239.00	
	42ATO Atomic 42" Round, Glass	\$397.30	\$516.50			MARCRD-Marina Chair, Red	\$183.85	\$239.00	
						MARCWH-Marina Chair, White Vnyl	\$183.85	\$239.00	
						TASKST-Task Stool	\$183.85	\$239.00	

Executive Seating

Qty.	Item	Discount	Regular	Amount
	PROEXE-Pro Executive Chair	\$463.95	\$603.15	
	PROEXB-Executive Chair High Back	\$463.95	\$603.15	
	PROGB-Guest Executive Chair	\$325.95	\$423.75	
	PROMDB-Exec Mid-Back, Black	\$304.55	\$395.90	
	PROMID-Executive Chair Mid Back	\$295.05	\$383.55	

Submission of this form indicates you read and accept the Payment Policy and Terms & Conditions.

There are no exchanges or refunds once item has been delivered to your booth. Cancellations must be received in writing within 14 days prior to first exhibitor move in day.

Rental items found and in use in your booth are subject to "Regular" pricing.

Total Conference: \$ _____

6.000% Tax*: \$ _____

Amount Due: \$ _____

Company Name: _____ Booth # _____

Contact Name _____

Email: _____

Signature: _____



Café and Communal Tables

North Atlanta Home Show

Infinite Energy Arena (Gwinnett Center) - Duluth, Georgia

February 7 - 9, 2020

Discount Deadline Friday, January 17, 2020

Order with complete Payment Authorization must be received before Discount Deadline date to receive discounted pricing.

Event Code: G175700220
 email: atlanta@shepardes.com
 phone: (404) 720-8600
 fax: (404) 720-8755

Café Tables

Café Tables- Black Base

Qty.	Item	Discount	Regular	Amount
	ZTK-30" Maple Top/Black Base	\$280.75	\$365.00	
	ZTP-36" Maple Top/Black Base	\$306.90	\$398.95	
	ZTJ-30" Graphite Top/Black Base	\$280.75	\$365.00	
	ZTN-36" Graphite Top/Black Base	\$306.90	\$398.95	
	ZTQ-36" White Laminate Top	\$306.90	\$398.95	
	ZTB-30" Red Top/Black Base	\$280.75	\$365.00	
	ZTA-30" Grey Top/Black Base	\$290.25	\$377.35	
	30WH29 -30" White Laminate	\$297.40	\$386.60	
	30BEBC-30" Blue Top/Black Base	\$281.20	\$365.55	
	30WDBC-30" Wood Top/Black Bas	\$281.20	\$365.55	

Café Tables - Chrome Base 30", Hydraulic

Qty.	Item	Discount	Regular	Amount
	30MTHC-Maple Top, Chrome	\$375.95	\$488.75	
	30GRHC-Graphite Nebula, Chrome	\$375.95	\$488.75	
	30BRHC-Brushed Red Top, Chrome	\$375.95	\$488.75	
	30MAHC-Grey Top, Chrome	\$375.95	\$488.75	
	30WHHC-White Laminate	\$406.90	\$528.95	
	30BEHC-Blue Top, Chrome	\$378.55	\$492.10	
	30WDHC-Wood Top, Chrome	\$378.55	\$492.10	

Café Tables - Chrome Base 36", Hydraulic

Qty.	Item	Discount	Regular	Amount
	36MTHC-Maple Top, Chrome	\$409.25	\$532.05	
	36GRHC-Graphite Nebula, Chrome	\$409.25	\$532.05	
	36WTHC-White Top, Chrome	\$409.25	\$532.05	

G30 and Ventura Communal Tables

30" High Tables

Qty.	Item	Discount	Regular	Amount
	VNTCBN-Black Top, Silver Frame	\$638.10	\$829.55	
	VNTCMN-Maple Top, Silver Frame	\$638.10	\$829.55	
	VNTCWN-White Top, Silver Frame	\$638.10	\$829.55	
	VNTCMW-Maple, w/ Grmt	\$638.10	\$829.55	
	VNTCWW-White, w/ Grmt	\$638.10	\$829.55	
	VNTCBK-Black Top- Powered!	\$724.60	\$942.00	
	VNTCWH-White Top- Powered!	\$724.60	\$942.00	

42" High Tables

	VNTBNP Communal Table Black Top	\$830.40	\$1,079.50	
	VNTMNP Communal Table Maple Top	\$830.40	\$1,079.50	
	VNTWNP Communal Table White Top	\$830.40	\$1,079.50	
	VNTBMW Comm Table Maple Top w/ Grom	\$830.40	\$1,079.50	
	VNTBWW Comm Table White w/ Grom	\$830.40	\$1,079.50	

Powered! 42" High Tables

Qty.	Item	Discount	Regular	Amount
	VNTBLK Communal Table Black Top	\$980.30	\$1,274.40	
	VNTWHT Communal Table White Top	\$980.30	\$1,274.40	

Submission of this form indicates you read and accept the Payment Policy and Terms & Conditions.

There are no exchanges or refunds once item has been delivered to your booth. Cancellations must be received in writing within 14 days prior to first exhibitor move in day.

Rental items found and in use in your booth are subject to "Regular" pricing.

Total Cafe: \$ _____
 6.000% Tax*: \$ _____
 Amount Due: \$ _____

Company Name: _____ Booth # _____

Contact Name _____

Email: _____

Signature: _____



Bar Tables, Barstools, Bars

North Atlanta Home Show

Infinite Energy Arena (Gwinnett Center) - Duluth, Georgia

February 7 - 9, 2020

Discount Deadline Friday, January 17, 2020

Order with complete Payment Authorization must be received before Discount Deadline date to receive discounted pricing.

Event Code: G175700220
 email: atlanta@shepardes.com
 phone: (404) 720-8600
 fax: (404) 720-8755

Bar Tables - All Black Base

Barstools

Qty.	Item	Discount	Regular	Amount	Qty.	Item	Discount	Regular	Amount
	VTK-30" Maple Top/Black Base	\$309.35	\$402.15			BST-Banana, White/Chrome	\$311.70	\$405.20	
	VTP-36" Maple Top/Black Base	\$330.70	\$429.90			BSS-Banana, Black/Chrome	\$311.70	\$405.20	
	VTJ-30" Graphite Top/Black Base	\$309.35	\$402.15			BS001-Shark, Swivel White	\$397.30	\$516.50	
	VTN-36" Graphite Top/Black Base	\$330.70	\$429.90			BS002-Zoey, Swivel White	\$364.05	\$473.25	
	VTW-36" White Laminate Top	\$330.70	\$429.90			BS003-Zoey, Swivel Black	\$364.05	\$473.25	
	VTB-30" Red Top/Black Base	\$309.35	\$402.15			RSTSTL-Rustique Barstool, Gunmetal	\$180.80	\$235.05	
	30WH42 30" White Laminate,	\$325.95	\$423.75			APS08-Apex Black Vinyl	\$280.75	\$365.00	
	VTA-30" Grey Top/Black Base	\$309.35	\$402.15			APS59-Apex Red Vinyl	\$280.75	\$365.00	
	RSTSQT Rustique Square Metal Bar Table	\$342.60	\$445.40			APS75-Apex White Vinyl	\$280.75	\$365.00	
	30BEBB-Blue Top/Black Base	\$313.65	\$407.75			APS12-Apex Blue Ultra Suede	\$280.75	\$365.00	
	30WDBB-Wood Top/Black Base	\$313.65	\$407.75			XBAR-Christopher White Vinyl	\$226.00	\$293.80	

Bar Tables - Chrome Base 30", Hydraulic

Qty.	Item	Discount	Regular	Amount	Qty.	Item	Discount	Regular	Amount
	30GRHB-Graphite Nebula, Chrome	\$375.95	\$488.75			LMBAR-Laguna, Maple/Chrome	\$233.15	\$303.10	
	30MTHB-Maple Top, Chrome	\$375.95	\$488.75			BSR-Syntax, Black/Chrome	\$283.15	\$368.10	
	30BRHB-Brushed Red, Chrome	\$375.95	\$488.75			ZENBAR-Zenith, White/Chrome	\$209.35	\$272.15	
	30WHHB White Laminate, Chrome	\$406.90	\$528.95			BSC-Oslo, White	\$328.35	\$426.85	
	30MAHB-Grey Top, Chrome	\$375.95	\$488.75			ROLLBL-Lift Barstool, Black Vinyl	\$264.15	\$343.40	
	30BEHB-Blue Top, Chrome	\$378.55	\$492.10			ROLLGY-Lift Barstool, Grey Vinyl	\$264.15	\$343.40	
	30WDHB-Wood Top, Chrome	\$378.55	\$492.10			ROLLRD-Lift Barstool, Red Vinyl	\$264.15	\$343.40	
						ROLLWH-Lift Barstool, White Vinyl	\$264.15	\$343.40	
						BLDBRD-Blade, Red	\$162.20	\$210.85	
						BLDBSB-Blade, Sky Blue	\$162.20	\$210.85	
						LUBSCL- Frosted, Acrylic	\$324.45	\$421.80	

Bar Tables - Chrome Base 36", Hydraulic

Bars and Counters

	36GRHB-Graphite Nebula, Chrome	\$409.25	\$532.05			MTBLPI-Midtown Bar, Lighted	\$1,849.35	\$2,404.15	
	36MTHB, Maple Top, Chrome	\$409.25	\$532.05			MTBUUL-Midtown Bar, unlighted	\$1,730.40	\$2,249.50	
	36WTHB-White Top, Chrome	\$409.25	\$532.05			MTCLPI- Midtown Counter, Lighted	\$1,849.35	\$2,404.15	
						MTCPUL- Midtown Counter, Unlighted	\$1,741.20	\$2,263.55	

Submission of this form indicates you read and accept the Payment Policy and Terms & Conditions.

There are no exchanges or refunds once item has been delivered to your booth. Cancellations must be received in writing within 14 days prior to first exhibitor move in day.

Rental items found and in use in your booth are subject to "Regular" pricing.

Total Bar: \$ _____
 6.000% Tax*: \$ _____
 Amount Due: \$ _____

Company Name: _____ Booth # _____

Contact Name _____

Email: _____

Signature: _____



North Atlanta Home Show

Infinite Energy Arena (Gwinnett Center) - Duluth, Georgia

February 7 - 9, 2020

Discount Deadline Friday, January 17, 2020

Order with complete Payment Authorization must be received before Discount Deadline date to receive discounted pricing.

Event Code: G175700220
 email: atlanta@shepardes.com
 phone: (404) 720-8600
 fax: (404) 720-8755

Desks, Credenzas, Files, Bookcases

Qty.	Item	Discount	Regular	Amount
	CR8-Madison Credenza, Grey	\$642.40	\$835.10	
	JD8-Madison Executive Desk, Grey	\$759.00	\$986.70	
	BC8-Madison Bookcase, Grey	\$549.60	\$714.50	
	TECH3B-Tech Desk w/drawers- Powered!	\$697.15	\$906.30	
	TECH-Tech Desk- Powered	\$563.90	\$733.05	
	TECH3-3-drawer File Cbnt w/Casto	\$185.60	\$241.30	

Work & Multi-Use Tables

Qty.	Item	Discount	Regular	Amount
	MERLIN-Multi Use Table	\$430.65	\$559.85	
	WD3-Work Table	\$414.00	\$538.20	

Product Display- Shelving

Qty.	Item	Discount	Regular	Amount
	PSHCCS-Posh Shelving	\$644.80	\$838.25	

Product Display- Pedestals

Qty.	Item	Discount	Regular	Amount
	PDL36B-Ped, Locking- Powered!	\$630.50	\$819.65	
	PDL42B-Ped, Locking- Powered!	\$747.10	\$971.25	
	PDL36W-Ped, Locking- Powered!	\$630.50	\$819.65	
	PDL42W-Ped, Locking- Powered!	\$747.10	\$971.25	

Lamps

Qty.	Item	Discount	Regular	Amount
	LA15-Mason Silver Floor Lamp	\$276.00	\$358.80	
	LA14-Mason Silver Table Lamp	\$180.80	\$235.05	

Hedge Walls

Qty.	Item	Discount	Regular	Amount
	HDG4FT-Boxwood Hedge, 4ft	\$551.55	\$717.00	
	HDG7FT-Boxwood Hedge, 7ft	\$897.65	\$1,166.95	

Submission of this form indicates you read and accept the Payment Policy and Terms & Conditions.

There are no exchanges or refunds once item has been delivered to your booth. Cancellations must be received in writing within 14 days prior to first exhibitor move in day.

Rental items found and in use in your booth are subject to "Regular" pricing.

Total Exec Accessories: \$ _____
 6.000% Tax*: \$ _____
 Amount Due: \$ _____

Company Name: _____ Booth # _____

Contact Name _____

Email: _____

Signature: _____



North Atlanta Home Show

Infinite Energy Arena (Gwinnett Center) - Duluth, Georgia

February 7 - 9, 2020

Event Code: G175700220
 email: atlanta@shepardes.com
 phone: (404) 720-8600
 fax: (404) 720-8755

Discount Deadline Wednesday, January 8, 2020

Order with complete Payment Authorization and graphic artwork must be received before Discount Deadline date to receive discounted pricing. Additional Rush charges may be applied to orders placed onsite.

Sign prices are based on customer supplying print-ready graphics in the requested format.

Foam Core Signs, Single sided

Vinyl Banners with Digital Printing

Qty.	Code	Item	Discount	Regular	Amount	Qty.	Code	Item	Discount	Regular	Amount
	70009	Vertical, 22" x 28"	\$175.90	\$228.65			70065	Grommets, per sq. ft.- Vertical	\$22.30	\$29.00	
	70010	Horz., 22" x 28"	\$175.90	\$228.65			70071	Grommets, per sq. ft. - Horizontal	\$22.30	\$29.00	
	70011	Vertical, 28" x 44"	\$267.90	\$348.25			70066	Pockets, per sq. ft. - Vertical	\$24.00	\$31.20	
	70012	Horz., 28" x 44"	\$267.90	\$348.25			70072	Pockets, per sq. ft.- Horizontal	\$24.00	\$31.20	
	70027	Meterboard, 38.25" x 90.75", trovicil panel	\$542.20	\$704.85							
	70138	39"x84" Meterboard, Ultraboard	\$315.00	\$409.50							

Please see our **Graphic Guidelines** page for specific file and artwork information.

See our **Graphic Upload** page for a step by step guide on uploading your artwork.

Accessories

Qty.	Code	Item	Discount	Regular	Amount
	70017	Blank Foamcore, 4' x 8'	\$47.75	\$62.10	
	70021	Velcro, per ft, min. 5 ft.	\$3.10	\$4.05	
	70004	7" x 44" ID Sign	\$52.60	\$68.40	
	50094	Floor Easel	\$47.15	\$61.30	
	50095	22x28 Sign Holder	\$107.35	\$139.55	
	50508	Cardboard Meterboard base, blk	\$21.00	\$27.30	

Table Clings Table clings are made to fit our Pedestal table tops!

Qty.	Code	Item	Discount	Regular	Amount
	70034	36"x36" Rnd Table Cling	\$187.10	\$243.25	

Submission of this form indicates you read and accept the Payment Policy and Terms & Conditions.

Due to the custom nature of this product, no refunds or cancellations are available once ordered.

Total Graphics: \$ _____
 6.000% Tax*: \$ _____
 Amount Due: \$ _____

Company Name: _____ Booth # _____

Contact Name _____

Email: _____

Signature: _____



North Atlanta Home Show

Infinite Energy Arena (Gwinnett Center) - Duluth, Georgia

February 7 - 9, 2020

Upload Deadline **Wednesday, January 8, 2020**

Orders with complete Payment Authorization and graphics must be received before
Upload Deadline date

Event Code:	G175700220
email	atlanta@shepardes.com
phone	(404) 720-8600
fax	(404) 720-8755

All graphic files for ordered products should be uploaded to our FTP site.

Address: https://files.shepardes.com/files/FTP%20Files/Drop%20Off/-2020/02_North%20Atlanta%20Home%20Show/Exhibitor%20Uploads

Username: **sesftp**

Password: **ftpftp**

- 1 Name your files in this format: Company Name_Booth#_Panel Letter **example:** **Shepard_1905_A**
- 2 When you are in your show folder, you can either drop and drop your files into the folder to initiate upload
or
You may click the Upload Files button and select the files you need to upload.
- 3 When upload is complete, email the name of your files to: **atlanta@shepardes.com**
As the subject line use: **"Show Name" FTP Upload**

Failure to follow these steps could result in delayed graphics.

Please see Graphic Guidelines page for file specifications.

North Atlanta Home Show

Infinite Energy Arena (Gwinnett Center) - Duluth, Georgia
February 7 - 9, 2020

Event Code: G175700220
email: atlanta@shepardes.com
phone: (404) 720-8600

ACCEPTABLE FILE FORMATS

Shepard uses the most current version of Adobe Creative Cloud. If providing native files from another version, please provide an .idml file.

Program	File Extension	Special Considerations
Adobe Acrobat	.pdf	Create using a high-quality output.*
Adobe Illustrator	.ai, .eps	Vector artwork. Images embedded and fonts changed to outlines** or a packaged file.
Adobe InDesign	.indd, .idml	Fonts changed to outlines** or a packaged file.
Adobe Photoshop	.tiff, .psd, .eps	Raster artwork. File should be in CMYK color space.

WE DO NOT ACCEPT: Microsoft® Word®, Excel®, or PowerPoint® files for artwork/graphics.

FONTS

If creating artwork in Adobe® InDesign® or Illustrator® there are two options when supplying fonts. Supply us with PC format TTF fonts. Change fonts to outlines. This prevents font substitution through layout and production. REMEMBER: if creating outlines, text is no longer editable.

Package the fonts from InDesign or Illustrator (File → Package → Check “Copy Fonts”) and submit with your artwork.

ARTWORK GUIDELINES

Document Size & Specs

All artwork should be created at 100% size at 150 dpi or in a proportionally scaled down format (ex. 50% at 300 dpi or 25% at 600dpi). NOTE: Mark artwork to the dimensions it is sized to if not 100%. All content should be kept within the live area, leave approximately 2" all the way around artwork to ensure sign holder or structure metal does not cut off content.

COLOR

All artwork should be created/supplied in the CMYK color space. Please provide Pantone® colors/HEX code if we need to match a specific color during the printing process. All PMS colors should be converted to CMYK Process Color in the artwork. NOTE: Converting color from RGB to CMYK will change the vibrancy and the look of some effects, DO NOT design artwork in RGB. Colors may vary due to output devices.

ARTWORK FILE TYPES & RESOLUTION

Artwork can be created in several ways. Here are some things to consider.

Vector

Vector-based artwork is resolution independent and can be enlarged or reduced without loss of quality. This is the preferred file type and is most often created in Adobe Illustrator and used for creation of logos and clip art.

Raster

This type of file is resolution dependent and will reproduce poorly if the appropriate file resolution is not supplied. If you supply raster art, it is best to save your artwork in a 1 to 1 (full size) output ratio at 150dpi or higher. Lower resolutions (1MB or smaller) will result in reduced image quality. File size should not exceed 200MB (if possible). Raster images are most often created in Adobe Photoshop® and is most often used for photographic images.

Resolution

Artwork should be 150dpi at 100% scale or 300dpi at half size. This will ensure the artwork remains high resolution when printed at full size. See samples below.

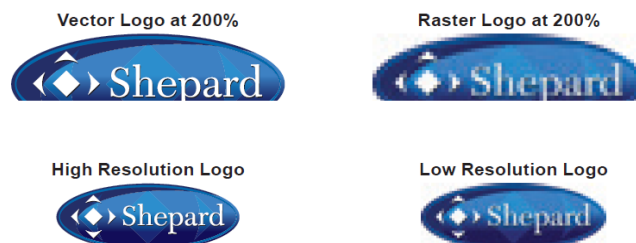

North Atlanta Home Show

Infinite Energy Arena (Gwinnett Center) - Duluth, Georgia
February 7 - 9, 2020

Event Code: G175700220
email: exhibits@shepardes.com
phone: 404-720-8652
fax: 404-720-8757

Order Deadline **Wednesday, January 8, 2020**

Order with full payment and graphic files must be received by Order Deadline Date above. Orders received after this date may not be available.

Turnkey Rental Designs Make Exhibiting Easier!

Don't See what you are looking for or need a tweak to a design?
Let one of our incredible designers create a space just for you! Contact an Exhibits team member to get started!

The Eddie

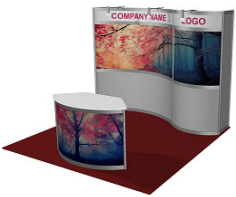

Code	Qty	Item	Discount	Regular
66470		The Eddie- 10' x 10'	\$3,344.85	\$4,348.30
66471		The Eddie- 10' x 20'	\$5,446.80	\$7,080.85
66474		The Jonathon - 10' x 10'	\$2,333.45	\$3,033.50
66475		The Jonathon - 10' x 20'	\$4,084.50	\$5,309.85

The Jonathon



The Pierce



Code	Qty	Item	Discount	Regular
66477		The Pierce - 10' x 10'	\$2,894.40	\$3,762.70
66478		The Pierce - 10' x 20'	\$5,495.65	\$7,144.35
66484		The Madison - 10' x 10'	\$3,509.95	\$4,562.95
66485		The Madison - 10' x 20'	\$4,159.90	\$5,407.85

The Madison



The Grant



Code	Qty	Item	Discount	Regular
66486		The Grant- 10' x 10'	\$3,704.85	\$4,816.30
66487		The Grant- 10' x 20'	\$5,134.85	\$6,675.30
66492		The Harrison - 10' x 10'	\$3,405.95	\$4,427.75
66493		The Harrison - 10' x 20'	\$5,004.80	\$6,506.25

The Harrison



The Hamilton

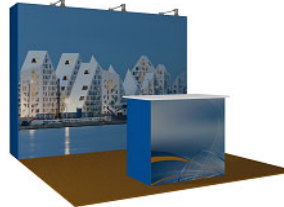

Code	Qty	Item	Discount	Regular
66467		The Hamilton- 10' x 10'	\$2,373.35	\$3,085.35
66468		The Hamilton- 10' x 20'	\$4,157.85	\$5,405.20
66473		The Lucy - 10' x 10'	\$2,144.95	\$2,788.45

The Lucy



Carpet and Electricity not included. Please order as needed. All Exhibit Booth Rentals include installation/dismantling and graphic panels as shown for print-ready graphics. If graphics submitted are not print-ready, additional fees may apply. Monitor and lighting options available. Please contact the Exhibits Department with any questions at 404-720-8652.

Submission of this form indicates you read and accept the Payment Policy and Terms & Conditions.

All orders cancelled by the exhibitor within 30 days of first day of exhibitor move in day may be subject to cancellation fees up to 100% of the total order, based upon the status of move-in, work performed and/or Shepard set-up costs or expenses. * All tax rates are subject to change.

Total Inline Rentals: \$ _____
6.000% Tax*: \$ _____
Amount Due: \$ _____

Company Name: _____ Booth # _____

Contact Name _____

Email: _____

Signature: _____

North Atlanta Home Show

Infinite Energy Arena (Gwinnett Center) - Duluth, Georgia

February 7 - 9, 2020

Order Deadline Wednesday, January 8, 2020

Order with full payment and graphic files must be received by Order Deadline Date above. Orders received after this date may not be available.

Event Code: G175700220
 email: exhibits@shepardes.com
 phone: 404-720-8652
 fax: 404-720-8757

Choose Your Counter & Customize to Fit Your Exhibit!

Color choices for all products Metal Colors Black (06) Silver (15) Panel Colors Black (06) White (03)

Locking Cabinets

LC1 1Meter Wide

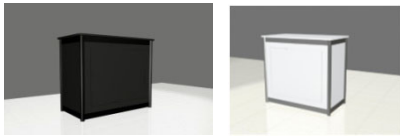

LC2 1.5 Meters Wide

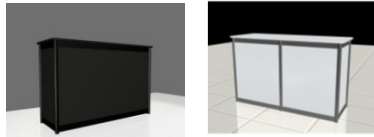

LC3

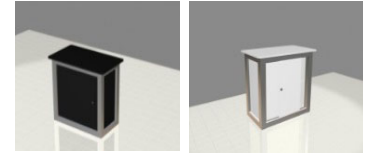

Code	Qty	Item	Product Size	Discount	Regular	Metal Color	Panel Color
66282		LC1	3' 6" L x 3' 6" H x 1' 9" D	\$822.35	\$1,069.05		
66283		LC2	5' L x 3' 6" H x 1' 9" D	\$997.90	\$1,297.25		
66284		LC3	3' 9" L x 3' 6" H x 2' 3" D	\$606.60	\$788.60	Silver Only	

Reception Counters

RC2

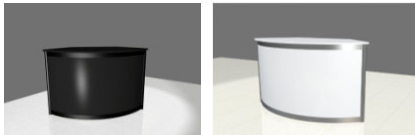

RC3

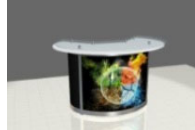

Code	Qty	Item	Product Size	Discount	Regular	Metal Color	Panel Color	Graphic Size:
66275		RC2	4' 9"L x 2' 3"D x 3' 3"H x 2' 3"D	\$845.65	\$1,099.35			Contact Us to Customize
66276		RC3	5' 3"L x 3' 6"H x 3' 3"D	\$1,834.45	\$2,384.80			1075mm x 885mm

Computer Stands-Silver Metal Only (graphic included!)

CS1



CS2

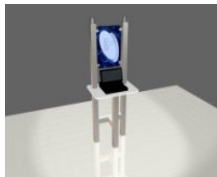

Code	Qty	Item	Product Size	Discount	Regular	Panel Color	Graphic Size
66285		CS1	3' L x 6' 3" H x 1' 9" D	\$1,066.80	\$1,386.85		250mm x 700mm
66286		CS2	2' 3" L x 6' 3" H x 1' 6" D	\$621.80	\$808.35		380mm x 580mm

Submission of this form indicates you read and accept the Payment Policy and Terms & Conditions.

All orders cancelled by the exhibitor within 30 days of first day of exhibitor move in day may be subject to cancellation fees up to 100% of the total order, based upon the status of move-in, work performed and/or Shepard set-up costs or expenses. * All tax rates are subject to change.

Total Counter Rentals: \$ _____
 6.000% Tax*: \$ _____
 Amount Due: \$ _____

Company Name: _____ Booth # _____

Contact Name _____

Email: _____

Signature: _____

North Atlanta Home Show

Infinite Energy Arena (Gwinnett Center) - Duluth, Georgia
February 7 - 9, 2020

Event Code: G175700220
email: exhibits@shepardes.com
phone: 404-720-8652
fax: 404-720-8757

Order Deadline **Wednesday, January 8, 2020**

Order with full payment and graphic files must be received by Order Deadline Date above. Orders received after this date may not be available.

Choose Your Unit & Customize to Fit Your Products!

Color choices for showcase and displays Metal Colors Black (06) Silver (15)

Panel Colors Black (06) White (03)

Product Displays

Gondolas



GL Display Units



Code	Qty	Item	Product Size	Discount	Regular	Metal Color	Panel Color	Graphic Size
66277		Gondola	3' 6" L x 1' 9" D x 5' H	\$576.25	\$749.15			NA
66278		GL1	5' 4" L x 8" H x 1' 3" D	\$569.65	\$740.55	Silver Only	NA	674mm x 1682mm
66279		GL2	4' 3" L x 7" H x 1' 3" D	\$981.90	\$1,276.45	Silver Only	NA	674mm x 1682mm

Showcases

Quarterview

Square

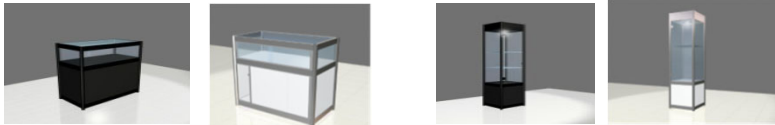

Code	Qty	Item	Product Size	Discount	Regular	Metal Color	Panel Color
66270		Qtrview	4' 6" L x 1' 9" D x 3' 3" H	\$1,109.50	\$1,442.35		
66272		Square	1' 9" L x 1' 9" D x 7" H	\$1,197.45	\$1,556.70		

Charging Units

Code	Qty	Item	Product Size	Discount	Regular	Panel Color	Graphic Size
66430		PCS	3' L x 6' 3" H x 1' 9" D	\$1,884.95	\$2,450.45	Black Only	250mm x 700mm

PCS



Perforated/Peg Boards

Code	Qty	Item	Product Size	Discount	Regular
66148		PerfH	4'x7' Pegboard panel	\$280.15	\$364.20
66149		PerfV	4'x8' Pegboard panel	\$280.15	\$364.20
50104		6" Pegs	6" Pegs 1 dozen	\$45.75	\$59.50
66147		Slatwall	8'x3.5' Slatwall grey vert	\$280.15	\$364.20

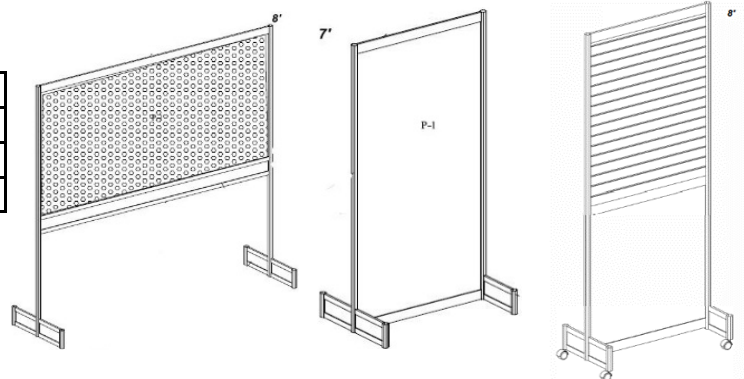

Submission of this form indicates you read and accept the Payment Policy and Terms & Conditions. Custom Product Display Rentals: \$ _____
All orders cancelled by the exhibitor within 30 days of first day of exhibitor move in day may be subject to cancellation fees up to 100% of the total order, based upon the status of move-in, work performed and/or Shepard set-up costs or expenses. * All tax rates are subject to change. 6.000% Tax*: \$ _____
Amount Due: \$ _____

Company Name: _____ Booth # _____
Contact Name _____
Email: _____
Signature: _____

North Atlanta Home Show

Infinite Energy Arena (Gwinnett Center) - Duluth, Georgia

February 7 - 9, 2020

Order Deadline Wednesday, January 8, 2020

Order with full payment and graphic files must be received by Order Deadline Date above. Orders received after this date may not be available.

 Event Code: G175700220
 email: exhibits@shepardes.com
 phone: 404-720-8652
 fax: 404-720-8757

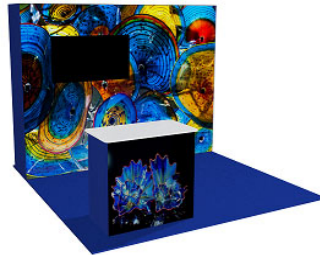
10x10 Fabric Booth Rental Display

Code	Qty	Item	Discount	Regular
66557		FX21 10' x 10'	\$2,205.60	\$2,867.30
66558		FX2M1 10' w/Monitor	\$3,990.05	\$5,187.05

Side panel colors are either white or black

Backwall graphic size 3042mm x 2432mm

Counter graphic size 1070mm x 1020mm

Monitor 66620

Code	Qty	Item	Discount	Regular
66561		FX2H1 10' x 10'	\$2,698.80	\$3,508.45
66562		FX2M1H 10' w/Monitor	\$4,483.30	\$5,828.30

Side panel colors are either white or black

Backwall graphic size 3042mm x 2432mm

Counter graphic size 1070mm x 1020mm

Header graphic size 2440mm x 380mm

Monitor 66620

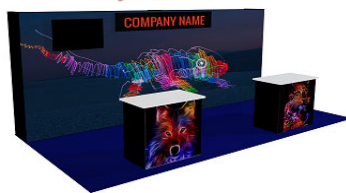
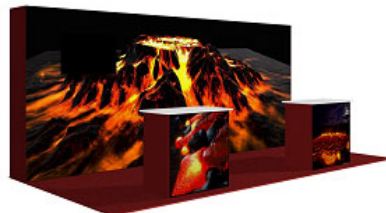
10x20 Fabric Booth Rental Display

Code	Qty	Item	Discount	Regular
66559		FX22 10' x 20'	\$3,823.05	\$4,969.95
66560		FX2M2 10' x 20' w/Monitor	\$5,607.55	\$7,289.80
66567		FX2H2 10' x 20'	\$4,264.20	\$5,543.45
66563		FX2M2H 20' w/Monitor	\$6,048.70	\$7,863.30

Side panel colors are white or black

Backwall graphic size 6012mm x 2432mm

Counter graphic size 1070mm x 1020mm

Header graphic size 2440mm x 380mm

Monitor 66620

****Please Note**** Carpet is not included, to order please refer to the Carpet Order form.

All Exhibit Booth Rentals include installation/dismantling and graphic panels as shown for print-ready graphics. If graphics submitted are not print-ready, additional fees may apply. Monitor and lighting options available. Please contact a Exhibit Team member with any customization requests at 404-720-8652.

 Submission of this form indicates you read and accept the Payment Policy and Terms & Conditions.
 All orders cancelled by the exhibitor within 30 days of first day of exhibitor move in day may be subject to cancellation fees up to 100% of the total order, based upon the status of move-in, work performed and/or Shepard set-up costs or expenses. * All tax rates are subject to change.

 Total Fabex Rental: \$ _____
 6.000% Tax*: \$ _____
 Amount Due: \$ _____

 Company Name: _____ Booth # _____
 Contact Name _____
 Email: _____
 Signature: _____

North Atlanta Home Show

Infinite Energy Arena (Gwinnett Center) - Duluth, Georgia

February 7 - 9, 2020

Order Deadline Wednesday, January 8, 2020

Order with full payment and graphic files must be received by Order Deadline Date above. Orders received after this date may not be available.

Event Code: G175700220
 email: exhibits@shepardes.com
 phone: 404-720-8652
 fax: 404-720-8757

Freestanding 8' high Backlit Backwalls with Full Color Graphics

FX 11- 8'h x 10'



Step 1: Choose Your Booth Size
Step 2: Send Us Your Full Color Graphics

Code	Qty	Item	Discount	Regular	Graphic Sizes
66564		FX11 10' x 10' Backlit	\$2,224.00	\$2,891.20	3042mm x 2436mm
66565		FX12 10' x 20' Backlit	\$3,437.05	\$4,468.15	6088mm x 2436mm
66566		FX13 10' x 30' Backlit	\$4,650.15	\$6,045.20	8992mm x 2436mm

Carpet/Flooring, Furnishings, Power and Accessories not included.

FX 12- 8'h x 20'

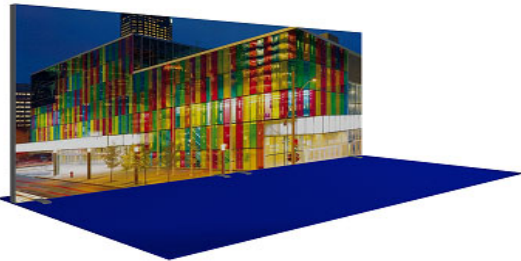

FX 13- 8' h x 30'



All Exhibit Booth Rentals include installation/dismantling and graphic panels as shown for print-ready graphics. If graphics submitted are not print-ready, additional fees may apply. Monitor and lighting options available. Please contact an Exhibits team member with any questions at 404-720-8652.

Submission of this form indicates you read and accept the Payment Policy and Terms & Conditions.

All orders cancelled by the exhibitor within 30 days of first day of exhibitor move in day may be subject to cancellation fees up to 100% of the total order, based upon the status of move-in, work performed and/or Shepard set-up costs or expenses. * All tax rates are subject to change.

Total Fabex Backlit: \$ _____
 6.000% Tax*: \$ _____
 Amount Due: \$ _____

Company Name: _____ Booth # _____
 Contact Name _____
 Email: _____
 Signature: _____

North Atlanta Home Show

Infinite Energy Arena (Gwinnett Center) - Duluth, Georgia

February 7 - 9, 2020

Order Deadline Wednesday, January 8, 2020

Order with full payment and graphic files must be received by Order Deadline Date above. Orders received after this date may not be available.

 Event Code: G175700220
 email: exhibits@shepardes.com
 phone: 404-720-8652
 fax: 404-720-8757

Turnkey Rental Designs Make Exhibiting Easier!

Don't See what you are looking for or need a tweak to a design? Let one of our incredible designers create a space just for you! Contact an Exhibits Team member to get started!

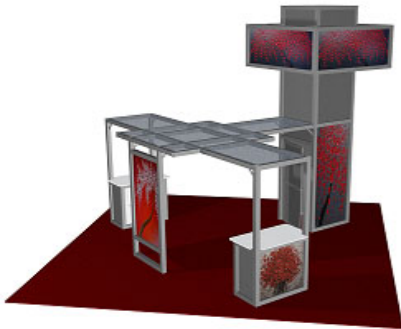
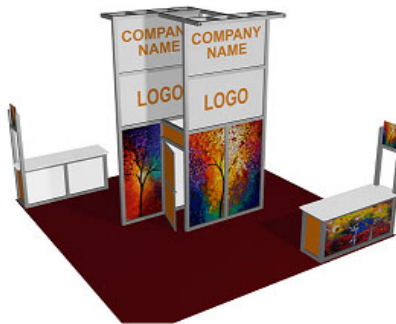
The Monroe

The Tyler

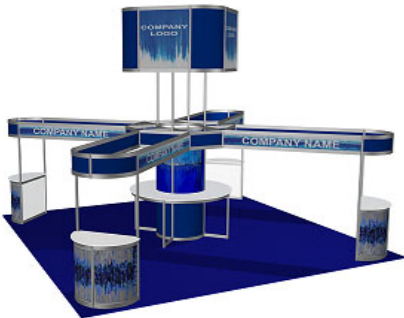
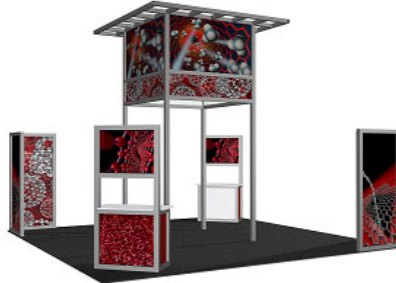
Code	Qty	Item	Discount	Regular
66494		The Monroe	\$8,514.70	\$11,069.10
66368		The Washington	\$12,219.65	\$15,885.55
66495		The Tyler	\$9,093.25	\$11,821.25
66496		The Garfield	\$8,904.70	\$11,576.10

The Washington

The Garfield

Carpet and Electricity not included. Please order as needed. All Exhibit Booth Rentals include installation/dismantling and graphic panels as shown for print-ready graphics. If graphics submitted are not print-ready, additional fees may apply. Monitor and lighting options available. Please contact an Exhibits team member with any questions at 404-720-8652.

Submission of this form indicates you read and accept the Payment Policy and Terms & Conditions.

All orders cancelled by the exhibitor within 30 days of first day of exhibitor move in day may be subject to cancellation fees up to 100% of the total order, based upon the status of move-in, work performed and/or Shepard set-up costs or expenses. * All tax rates are subject to change.

 Total Island Rentals: \$ _____
 6.000% Tax*: \$ _____
 Amount Due: \$ _____

Company Name: _____ Booth # _____

Contact Name _____

Email: _____

Signature: _____

LABOR

Georgia is a "right-to-work" state. Exhibitor personnel may set up their own exhibits if so desired using their own tools and company personnel. Union Labor is available to assist in the installation and dismantling of exhibit booths. Exhibit labor, freight and rigging labor, electricians and plumbers can be arranged for at established rates, using the enclosed order forms.

EXHIBIT LABOR JURISDICTION

Exhibit labor claims jurisdiction for the installation, dismantling, and first cleaning of prefabricated exhibits and displays when this work is done by Shepard personnel. They may be employed by completion of labor forms enclosed in this manual.

Union Labor is not required to put your products on display, to open cartons containing your products, nor to perform testing, maintenance or repairs on your products

MATERIAL/FREIGHT HANDLING JURISDICTION

Shepard Exposition Services has the responsibility of receiving and handling all exhibit materials and empty crates that comes in via over the road carriers. It is Shepard's responsibility to manage docks and schedule vehicles for the smooth and efficient move-in and move-out of the exhibition. Shepard will not be responsible, however, for any materials they do not handle. Exhibitors may not operate or utilize any type of powered or mechanical equipment

Vehicles must not be left unattended at the loading areas. Any unattended vehicles will be towed at the owner's expense.

The Fire Marshal absolutely prohibits the storage of empty containers in the exhibit hall. Arrangements have been made with Shepard Exposition Services to store empty crates. Please refer to the Material Handling Information sheet in this service manual for the handling of empties, disposal of skids, etc.

GRATUITIES /BREAKS

Tipping is expressly prohibited. This includes such practices as giving money, merchandise, or other special consideration for services rendered. Do not give coffee breaks other than mid-morning and mid-afternoon, when the union has a 15 minute paid break. Meal breaks are one hour. Any attempt to solicit a gratuity by an employee for any service should be reported immediately to Shepard Exposition Services.

IN GENERAL

Exhibitors do not have to respond to grievances or complaints from union and trade personnel with respect to work jurisdictions. Please refer all such disputes and/or questions to Shepard management personnel immediately.

SAFETY

Safety of everyone working in the hall is of our utmost concern at all times. Standing on chairs, tables and other rental furniture is prohibited. This furniture is not engineered to support your standing weight. Shepard Exposition Services cannot be held responsible for injuries or falls caused by the improper use of this furniture. If assistance is required in assembling your booth, please order labor on the Labor Order Form included in this manual and the necessary ladders and tools will be provided.



North Atlanta Home Show

Infinite Energy Arena (Gwinnett Center) - Duluth, Georgia

February 7 - 9, 2020

Event Code: G175700220
email atlanta@shepardes.com
phone (404) 720-8600
fax (404) 720-8755

Discount Deadline Friday, January 17, 2020

Order with complete Payment Authorization must be received before Discount
Deadline date to receive discounted pricing.

Labor Hours

ST - Straight time: Monday - Friday 8AM - 5PM.
OT - Overtime: Monday - Friday 6AM - 8AM and 5PM - Midnight. Saturdays and Sundays 6AM - Midnight.
DT - Double-time: All hours between Midnight and 6AM. Holidays.
Holidays:

Shepard Blue Supervised Install Labor			
Code		Discount	Regular Estimate
68066	ST	\$99.62	\$129.50
68067	OT	\$148.40	\$192.90
68068	DT	\$199.24	\$259.00

Shepard Blue Supervised Dismantle Labor			
Code		Discount	Regular Estimate
68070	ST	\$99.62	\$129.50
68071	OT	\$148.40	\$192.90
68072	DT	\$199.24	\$259.00

Booth Size: _____ X _____

**Pricing includes Supervisory fee of 30% over standard labor .

Step One:

Choose Your **Service**

- Installation
- Dismantling
- Both

Step Two:

How Many **People**?

- # _____
- # _____
- # _____

Step Three:

How Many **Hours**?

- # _____
- # _____
- # _____

Step Four:

When Should the Build be **Complete**?

- Date: _____ Time: _____
- Date: _____ Time: _____
- Date: _____ Time: _____

Step Five: Tell Us About Your Exhibit! (this portion **must be completed** before Shepard can begin any work on your exhibit)

Inbound Freight Advance Warehouse Direct to Show site

Carrier Name _____ Tracking or Pro # _____
Estimated Arrival Date _____ # of Pieces _____ Estimated Weight _____

Set Up Information:

Company Contact Name: _____
Email _____
Cell Phone # _____

Drawings/Photos/ Instructions:

- Attached
- Emailed to Shepard
- With the Exhibit
- In crate # _____

Graphics:

- With Exhibit
- Shipped Separately

Electrical Placement

(exhibitor is responsible to order)

- Emailed to Shepard
- Drawing Attached
- Drawing with Exhibit
- Run under carpet

Other Services

Ordered:

- Overhead Rigging
- Cleaning
- AV

Carpet:

- Ordered from Shepard
- Exhibitor Owned Carpet
- Carpet Padding

Outbound Shipping:

of Crates _____
of Cartons _____
of Fiber Cases _____
of Pallets _____

Method:

- Ground
- 2-Day Air
- Next Day Air
- Other

Phone # _____

Must Arrive at Destination By: _____

Name of Carrier _____

Date Carrier is Scheduled to Pick Up Freight _____

*Allow time for empty return when scheduling your pick up

If Your Carrier doesn't show? Reroute with SLS
 Send to advance warehouse for pick up (\$400 minimum charge)

Hours are based on estimates. You will be invoiced for actual time incurred. Minimum one hour per person ordered and half increments thereafter.

Estimated **SES Blue Labor**: \$ _____
NA Tax*: \$ _____
Amount Due: \$ _____

Orders cancelled without 48-hour written notice will be charged a one (1) hour cancellation fee.

Company Name: _____ Booth # _____
Contact Name _____
Email: _____
Signature: _____



Exhibitor Supervised Labor

North Atlanta Home Show

Infinite Energy Arena (Gwinnett Center) - Duluth, Georgia

February 7 - 9, 2020

Event Code: G175700220

email atlanta@shepardes.com

phone (404) 720-8600

fax (404) 720-8755

Discount Deadline Friday, January 17, 2020

Order with complete Payment Authorization must be received before Discount Deadline date to receive discounted pricing.

Labor Hours

ST - Straight time: Monday - Friday 8AM - 5PM.

OT - Overtime: Monday - Friday 6AM - 8AM and 5PM - Midnight. Saturdays and Sundays 6AM - Midnight.

DT - Double-time: All hours between Midnight and 6AM. Holidays.

Holidays:

Exhibitors may not operate any type of mechanical or powered equipment.

Exhibitor Supervised Install Labor

Code		Discount	Regular	Estimate
68060	ST	\$76.63	\$99.60	
68061	OT	\$114.15	\$148.40	
68062	DT	\$153.26	\$199.25	

Exhibitor Supervised Dismantle Labor

Code		Discount	Regular	Estimate
68063	ST	\$76.63	\$99.60	
68064	OT	\$114.15	\$148.40	
68065	DT	\$153.26	\$199.25	

Step One:

Choose your service

- Installation
- Dismantling
- Both

Step Two:

How many people?

Step Three:

How many hours?

Step Four:

Carpet:

- Ordered from Shepard
- Exhibitor Owned Carpet
- Carpet Padding

Step Five:

Any other details?

Any special tools needed? Ladders? Lifts?

- Ladders
- Lifts

Special Tools: _____

Details: _____

Step Six: Schedule

	Date	Start Time	End Time
Installation Request			
Dismantle Request			

Requested times are not guaranteed and are based on availability.

Step Seven: Onsite Contact Info

Name: _____

Cell: _____

Email: _____

Hours are based on estimates. You will be invoiced for actual time incurred. Minimum one hour per person ordered and half increments thereafter.

Orders cancelled without 48-hour written notice will be charged a one (1) hour cancellation fee.

Labor Estimate \$ _____

NA Tax*: \$ _____

Amount Due: \$ _____

Company Name: _____ Booth # _____

Contact Name: _____

Email: _____

Signature: _____